

Wilkhahn

Stitz 2. 20 range.





Stitz 2

The Stitz sitting-perching stool is an exceptional piece of furniture, that involves neither sitting nor standing, but somewhere in between. What is so ingenious about Stitz, is that it allows the body to relax but puts it through its paces at the same time. Which is why you do not sit on Stitz, but rest on it at a slant. As a result, your pelvis adopts an upright position, your metabolism improves, your sense of balance is enhanced and your muscles are activated without subjecting them to too much strain.

You can sit on the round seat from all sides. The elastomer base is filled with quartz sand, so that Stitz does not topple over even when tilted. A freely accessible disc underneath the seat lets you infinitely adjust the support height with an integrated gas lift.

But Stitz is not just considered a symbol of superb design. A study carried out by the Centre for Health at the German Sport University Cologne verifies that regular use of Stitz boosts your body's co-ordinating skills.



Stitz 2. 20 range. Technical details.

Wilkhahn

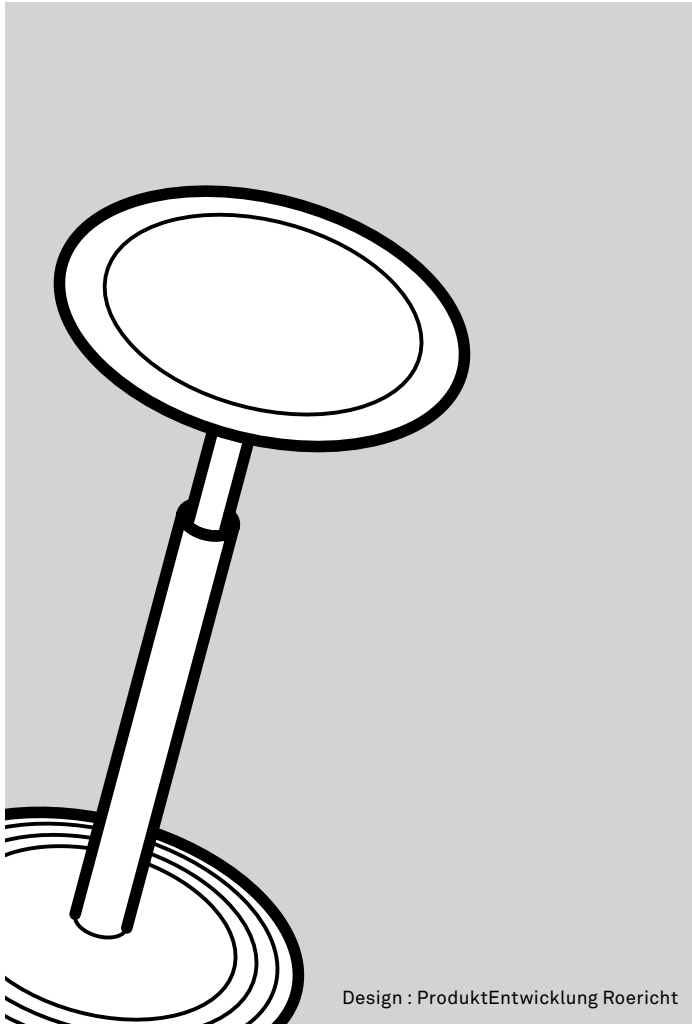

Design : ProduktEntwicklung Roericht

Function

Stitz is a sitting-standing stool with precision height adjustment via an encapsulated gas lift.

Frame

Black elastomer base filled with quartz sand. Black polyamide base plate.

Seat

Black polyamide seat frame. Cork insert, either treated with hard wax, covered with fabric or embossed leather. A black polyamide grip all the way round the seat to operate the gas lift.

Stitz 2. 20 range. Product types.

Wilkhahn



201/1 Seat surface cork, frame black



201/2 Seat surface covered in leather, frame black



201/2 Seat surface covered in fabric

Stitz 2. 20 range. Product types.

Wilkhahn

Frame surfaces



Black

Seat/upholstery materials

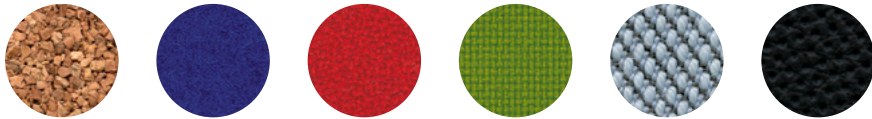

Cork, fabrics: 60 Blend | 63 Auris | 66 Lona | 91 Kvadrat Steelcut Trio 3 | leather: 74 |
You can find all upholstery materials and more colours in our media center

The digital sample colours differ from the originals.
You can find our current fabric collection in our media center.

Stitz 2. 20 range. Models and dimensions.

Wilkhahn

201/1
Seat surface cork
Frame black

201/2
Frame black

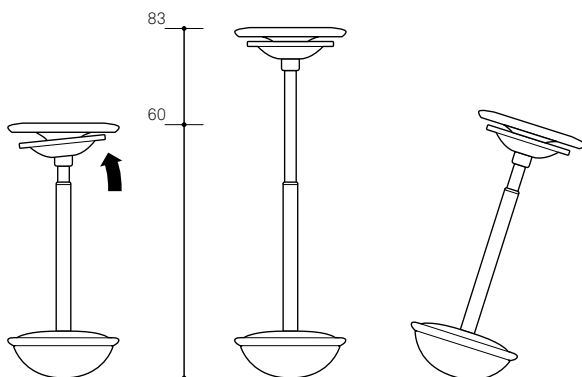
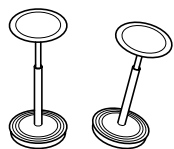
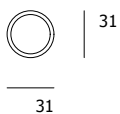
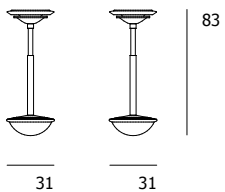

Stitz 2. 20 range. Models and dimensions.

Wilkhahn

The Stitz is a mobile sitting-perching stool to activate your muscles and increase your sense of balance. When in use, the Stitz requires three legs for a firm and safe stand: it needs yours too. If you increase the height and reduce the incline of the Stitz seat, this applies more pressure to your legs and less to your back. As you lower the seat and increase its incline this will have the reverse effect of relieving pressure on your legs while increasing it on your back. To achieve optimum ergonomic benefit, it is therefore advisable to change the height and supporting angle of your Stitz frequently.

Please note: the Stitz only provides a firm stand when the seat is at a slight forward incline and you apply some pressure to your legs. You should therefore never use a Stitz as a stool or a chair. If you remove all pressure from your legs and lean to the side or backward, you are bound to topple over.

The Stitz is a sitting-perching stool and its name stems from the German “Steh-Sitz” (standing and sitting). It involves neither sitting nor standing, but a position in between. The base comprises a non-skid elastomer pouch filled with quartz sand. The Stitz is therefore very versatile. It provides a means of support that adapts to any movement and tilts in any direction, and even staunchly stands its ground when not in use.

The Stitz is adjusted correctly in height when users can rest on the seat at a comfortable incline with their feet firmly on the ground (as shown in the illustration).

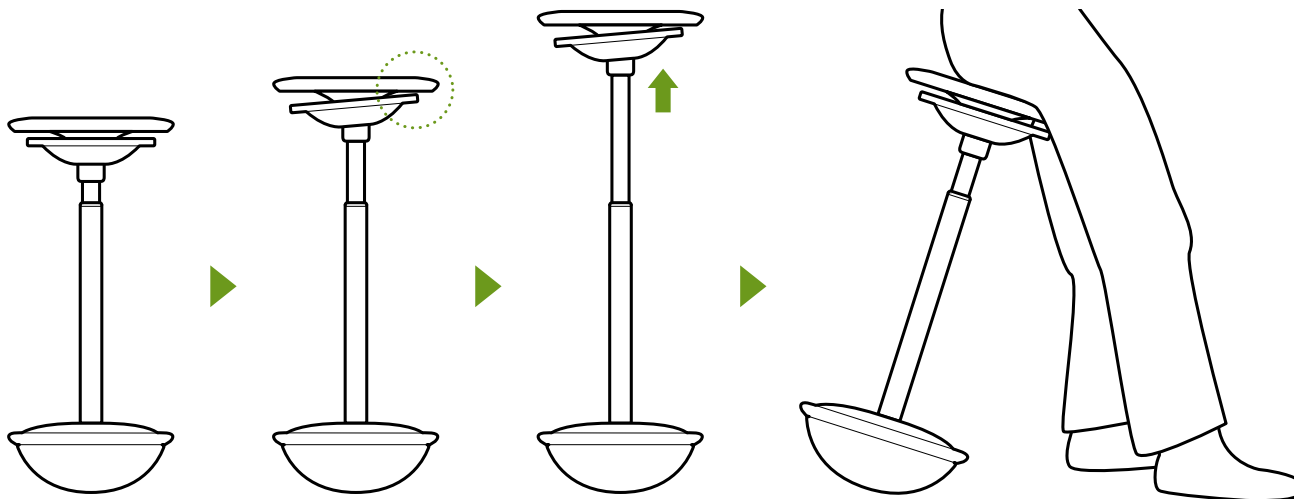

Stitz 2. 20 range. Awards/standards/certificates.

Wilkhahn

Awards



Product certificates / product standards



Company's certificates, memberships



Environment and product

Less is more – in ecological terms too

The art of omission is not only a prime aesthetic criterion but an ecological one too: in combination with enduring, high-performance materials it ensures virtually limitless service life and avoids any superfluous components.

- The frame of the Stitz comprises an encapsulated gas lift in steel, allowing precision-adjustment of its height. The gas lift can be easily exchanged and recycled, and a base comprising a black, through-dyed elastomer pouch filled with quartz sand.
- The seat with an operating disc with all-round access for height adjustment is in scratch-resistant, through-dyed polyamide. The exchangeable seat inset is made from cork – a renewable material – and may be either waxed, or covered with fabric or leather.

The Stitz 2 is an impressive example of how a design concept that consistently focuses on the simplest and highest quality solution can result in products that are both useful and virtually limitlessly lasting: “We strive to develop lasting products, increase their utility value and reduce waste” (from the Founding Manifesto of the Ulm Academy of Design, 1955 where Nick Roericht was first a student and then taught).

You can find our environmental product information in our media center.