

De Vorm

De Vorm meubelen Price List 2025

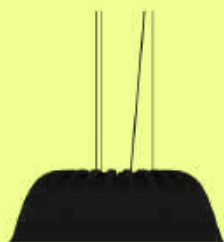
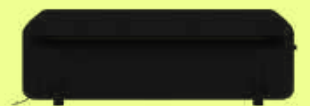

Products (1/2)

Chairs & Stools

Hale Series

Hale Stack Chair	5
Hale Stack Chair Armrests	5
Hale Counter Stool	6
Hale Counter Stool Armrests	6
Hale Bar Stool	7
Hale Bar Stool Armrests	7
Hale Series Upholstered Seat	8

LJ Series

LJ 1 Armchair	9
LJ 2 Stack Chair	10
LJ 3 Bar Stool	11
LJ 4 Counter Stool	12
LJ Series Upholstered Seat	13

Twist Series

Twist Stack Stool	14
Twist Counter Stool	15
Twist Bar Stool	16
Twist Series Upholstered Seat	17

Privacy Chairs

Pod Privacy Chair	19
-------------------	----

Lounge Chairs

Hale Lounge Chair	21
Hale Lounge Chair Armrests	21
Hale Lounge Chair Upholstered Seat	22
Nook Lounge Chair	23
Daddy's Lounge Chair	24

Couches

Arnhem Series

Arnhem Sofa 71	26
Arnhem Sofa 94	26
Arnhem Sofa 118	26
Arnhem Sofa 141	26
Arnhem Loveseat 71	27
Arnhem Loveseat 94	27
Arnhem Loveseat 118	27
Arnhem Loveseat 141	27
Arnhem Sofa Goes Room 71	28
Arnhem Sofa Goes Room 94	28
Arnhem Sofa Goes Room 118	28
Arnhem Sofa Goes Room 141	28
Arnhem Loveseat Goes Room 71	29

Arnhem Loveseat Goes Room 94	29
Arnhem Loveseat Goes Room 118	29
Arnhem Loveseat Goes Room 141	29

Upside Down Series

Upside Down Couch 205	30
Upside Down Couch 235	30
Upside Down Couch 265	30
Upside Down Couch Island 185	31
Upside Down Couch Island 215	31
Upside Down Couch Island 245	31

Florian Series

Florian Chair	32
Florian Bench	32

Mino Sofa Modular System

Configuration options	33
-----------------------	----

Tables

Big Modular Table System

Big 74	40
Big 95	40
Big 110	40
Big Round 74	41
Big Round 95	41
Big Round 110	41

Lite Modular Table System

Lite 74	42
Lite 95	42
Lite 110	42
Lite Round 74	43
Lite Round 95	43
Lite Round 110	43

Table Add-ons

Cable Cubbies + Tray	44
----------------------	----

Column Series

Column Table Round 60	45
Column Table Round 90	45
Column Table Round 120	45

MG Series

MG 1 Side Table	46
MG 2 Side Table	46
MG 3 Table	47
MG 4 Table	47

Products (2/2)

Pico

Pico Coffee Table	48
-------------------	----

Musette Series

Musette Coffee Table	49
Musette Side Table	49

Hale Table

Hale Table White	50
Hale Table Black	50

Acoustics

Mute Series

Mute Fit Acoustic Panel	52
Mute Fraction Acoustic Panel	53
Mute Flat Acoustic Panel	54
Mute Flow Acoustic Panel	55
Mute Peak Acoustic Panel	56
Mute Flow Floating	57
Mute Flow Floating Lamp	58
Mute Flow Room Divider	59

AK Series

AK 1 Workplace Divider	60
AK 2 Workplace Divider Lamp Hanging	61
AK 2 Workplace Divider Lamp Standing	61
AK 3 Workplace Divider Hanging (horizontal)	62
AK 3 Workplace Divider Standing (horizontal)	62
AK 3 Desk Clamp	62
AK 4 Workplace Divider Hanging (horizontal)	63
AK 4 Workplace Divider Standing (horizontal)	63
AK 4 Desk Clamp	63
AK 3 Room Divider Hanging (vertical)	64
AK 3 Room Divider Standing (vertical)	64
AK 4 Room Divider Hanging (vertical)	65
AK 4 Room Divider Standing (vertical)	65
Hinge AK 3 + 4	66

Lighting

Pivot Series

Pivot Adjustable Lamp	68
Pivot Adjustable Lamp Duo	68

Fost Series

Fost Acoustic Lamp	69
Fost Large Acoustic Lamp	70
Fost Bulb Acoustic Lamp	71
Fost Large Bulb Acoustic Lamp	72

Ratio Series

Ratio 19 Pendant Lamp	73
Ratio 29 Pendant Lamp	73
Ratio 39 Pendant Lamp	73

Split Series

Split Straight	74
Split Straight Drum	74
Split Straight Acorn	74
Split Straight Orbit	75
Split Straight Dome	75
Split Round	76
Split Round Drum	76
Split Round Orbit	76
Split Round Dome	77
Split Round Acorn	77

Additional Information

Mute Panels Fire Treatment	79
Fabrics (Kvadrat)	80
Ton-sur-ton colour combinations	81

General Terms & Conditions

Terms	83
Conditions	84

Chairs & Stools

Hale Series

	Seat + Backrest	Qty	Frame Black/White	Frame Custom Colour ¹	Frame Fine Texture ²
Hale Stack Chair 	Dark Grey, Light Grey	1	€ 275,00	€ 315,00	€ 322,00
	Colour blends	1	€ 292,00	€ 332,00	€ 338,00

Hale Stack Chair Armrests 	Dark Grey, Light Grey	1	€ 308,00	€ 348,00	€ 355,00
	Colour blends	1	€ 325,00	€ 365,00	€ 372,00

Setup costs custom colour treatment (frame)
 Setup costs for the first colour are € 225,00
 Setup costs for every next colour are € 75,00

Measurements

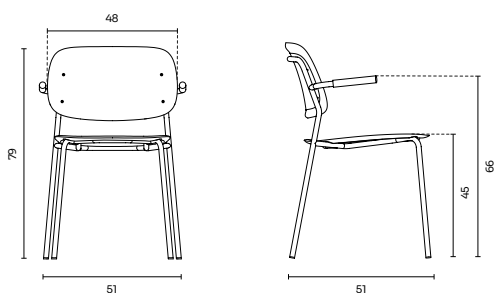

Upholstered seat



Hale Stack Chair with upholstered seat



Hale Stack Chair Armrests with upholstered seat

Specifications

Designed by

Frame

Standard frame colours

Seat + backrest

PET Felt blends

De Vorm & Ivan Kasner

Powder-coated steel

Black (RAL 9011) / White (RAL 9010)

with 70% gloss degree

PET Felt

Marine, Turquoise, Olive, Dark Green, Green, Yellow, Pink, Dark Grey, Light Grey, Brown, Beige

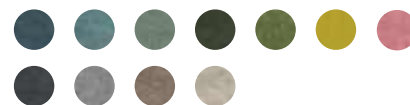

Upholstered seat

Hale Stack Chair and Hale Stack Chair Armrests are also available with an upholstered seat. Please, find the surcharges on page 8.

Bespoke options

¹ Specified costs are based on custom RAL colours as shown at in gloss degree 70%. Please, contact De Vorm for availability of the preferred colour. If the RAL colour is not in stock, there may be a price consequence.

² Specified costs are based on and only available in the following RAL fine texture colours: RAL 1012, RAL 3005, RAL 5008, RAL 5020, RAL 6007, RAL 6020, RAL 7015, RAL 7033, RAL 7044, RAL 7045, RAL 8014, RAL 9011.

*These colours match perfectly with our PET Felt blends.
 See page 81 for ton-sur-ton colour combinations.*

Additional information

PET Felt is made of recycled material. Slight colour deviations may appear between different products.

Hale Series

	Seat + Backrest	Qty	Frame Black/White	Frame Custom Colour ¹	Frame Fine Texture ²
Hale Counter Stool	Dark Grey, Light Grey	1	€ 342,00	€ 382,00	€ 388,00
	Colour blends	1	€ 358,00	€ 398,00	€ 405,00



Hale Counter Stool Armrests	Dark Grey, Light Grey	1	€ 375,00	€ 415,00	€ 422,00
	Colour blends	1	€ 383,00	€ 423,00	€ 430,00



Setup costs custom colour treatment (frame)
 Setup costs for the first colour are € 225,00
 Setup costs for every next colour are € 75,00

Measurements

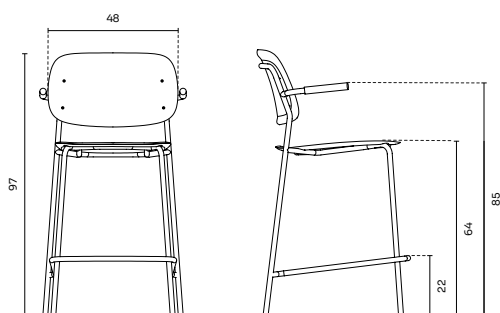

Upholstered seat



Hale Counter Stool with upholstered seat



Hale Counter Stool Armrests with upholstered seat

Specifications

Designed by
 Frame
 Standard frame colours

Seat + backrest
 PET Felt blends

De Vorm & Ivan Kasner
 Powder-coated steel
 Black (RAL 9011) / White (RAL 9010)
 with 70% gloss degree
 PET Felt
 Marine, Turquoise, Olive, Dark Green,
 Green, Yellow, Pink, Dark Grey, Light Grey,
 Brown, Beige

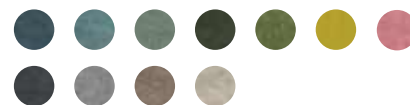

Upholstered seat

Hale Counter Stool and Hale Counter Stool Armrests are also available with an upholstered seat. Please, find the surcharges on page 8.

Bespoke options

¹ Specified costs are based on custom RAL colours as shown at in gloss degree 70%. Please, contact De Vorm for availability of the preferred colour. If the RAL colour is not in stock, there may be a price consequence.

² Specified costs are based on and only available in the following RAL fine texture colours: RAL 1012, RAL 3005, RAL 5008, RAL 5020, RAL 6007, RAL 6020, RAL 7015, RAL 7033, RAL 7044, RAL 7045, RAL 8014, RAL 9011.

*These colours match perfectly with our PET Felt blends.
 See page 81 for ton-sur-ton colour combinations.*

Additional information

PET Felt is made of recycled material. Slight colour deviations may appear between different products.

Hale Series

	Seat + Backrest	Qty	Frame Black/White	Frame Custom Colour ¹	Frame Fine Texture ²
Hale Bar Stool	Dark Grey, Light Grey	1	€ 342,00	€ 382,00	€ 388,00
	Colour blends	1	€ 358,00	€ 398,00	€ 405,00



Hale Bar Stool Armrests	Dark Grey, Light Grey	1	€ 375,00	€ 415,00	€ 422,00
	Colour blends	1	€ 383,00	€ 423,00	€ 430,00



Setup costs custom colour treatment (frame)
Setup costs for the first colour are € 225,00
Setup costs for every next colour are € 75,00

Measurements

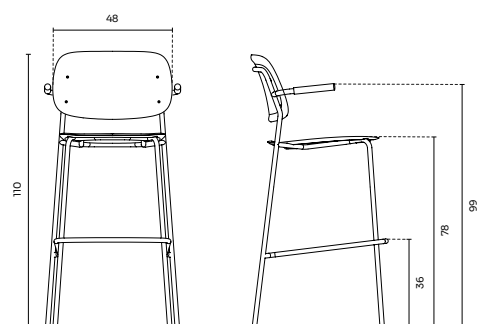

Upholstered seat



Hale Bar Stool with upholstered seat



Hale Bar Stool Armrests with upholstered seat

Specifications

Designed by
Frame
Standard frame colours

Seat + backrest
PET Felt blends

De Vorm & Ivan Kasner
Powder-coated steel
Black (RAL 9011) / White (RAL 9010)
with 70% gloss degree
PET Felt
Marine, Turquoise, Olive, Dark Green,
Green, Yellow, Pink, Dark Grey, Light Grey,
Brown, Beige

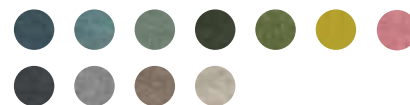

Upholstered seat

Hale Bar Stool and Hale Bar Stool Armrests are also available with an upholstered seat. Please, find the surcharges on page 8.

Bespoke options

¹ Specified costs are based on custom RAL colours as shown at in gloss degree 70%. Please, contact De Vorm for availability of the preferred colour. If the RAL colour is not in stock, there may be a price consequence.

² Specified costs are based on and only available in the following RAL fine texture colours: RAL 1012, RAL 3005, RAL 5008, RAL 5020, RAL 6007, RAL 6020, RAL 7015, RAL 7033, RAL 7044, RAL 7045, RAL 8014, RAL 9011.

*These colours match perfectly with our PET Felt blends.
See page 81 for ton-sur-ton colour combinations.*

Additional information

PET Felt is made of recycled material. Slight colour deviations may appear between different products.

Hale Series

Hale Series Upholstered Seat



Hale Chair
with upholstered seat



Hale Chair Armrests
with upholstered seat



Hale Counter Stool
with upholstered seat



Hale Counter Stool
Armrests with
upholstered seat



Hale Bar Stool
with upholstered seat



Hale Bar Stool Armrests
with upholstered seat

Qty	Fabric	Surcharge Ex. VAT
1 - 9	A	€ 208,00
	B	€ 217,00
	C	€ 225,00
	D	€ 233,00
	E	€ 242,00
	F	€ 250,00
10 - 24	A	€ 183,00
	B	€ 192,00
	C	€ 200,00
	D	€ 208,00
	E	€ 217,00
	F	€ 225,00
25 - 49	A	€ 167,00
	B	€ 175,00
	C	€ 183,00
	D	€ 192,00
	E	€ 200,00
	F	€ 208,00
> 50	A	€ 158,00
	B	€ 167,00
	C	€ 175,00
	D	€ 183,00
	E	€ 192,00
	F	€ 200,00

Find the overview of available fabrics on page 80.

LJ Series

LJ1 Armchair	Shell	Qty	Frame Black/White	Frame Custom Colour ¹	Frame Fine Texture ²
	Dark Grey, Light Grey	1	€ 325,00	€ 365,00	€ 372,00
	Colour blends	1	€ 350,00	€ 390,00	€ 397,00

Setup costs custom colour treatment (frame)
 Setup costs for the first colour are € 225,00
 Setup costs for every next colour are € 75,00

Measurements

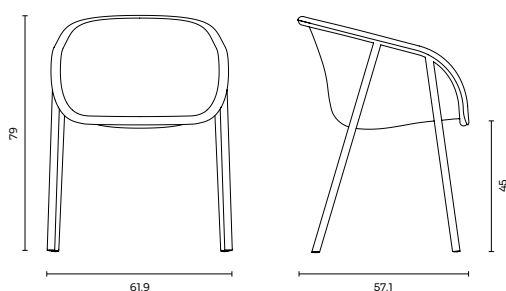

Upholstered seat



LJ1 Armchair with upholstered seat

Specifications

Designed by
 Frame
 Standard frame colours

Laurens van Wieringen
 Powder-coated steel
 Black (RAL 9011) / White (RAL 9010)
 with 70% gloss degree

Shell
 PET Felt blends

PET Felt
 Marine, Turquoise, Olive, Dark Green,
 Green, Yellow, Pink, Dark Grey, Light Grey,
 Brown, Beige

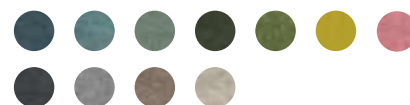

Upholstered seat

LJ1 Armchair is also available with an upholstered seat. Please, find the surcharges on page 13.

Bespoke options

¹ Specified costs are based on custom RAL colours as shown in gloss degree 70%. Please, contact De Vorm for availability of the preferred colour. If the RAL colour is not in stock, there may be a price consequence.

² Specified costs are based on and only available in the following RAL fine texture colours: RAL 1012, RAL 3005, RAL 5008, RAL 5020, RAL 6007, RAL 6020, RAL 7015, RAL 7033, RAL 7044, RAL 7045, RAL 8014, RAL 9011.

*These colours match perfectly with our PET Felt blends.
 See page 81 for ton-sur-ton colour combinations.*

Additional information

PET Felt is made of recycled material. Slight colour deviations may appear between different products.

LJ Series

LJ 2 Stack Chair	Shell	Qty	Frame Black/White	Frame Custom Colour ¹	Frame Fine Texture ²
	Dark Grey, Light Grey	1	€ 317,00	€ 357,00	€ 363,00
	Colour blends	1	€ 333,00	€ 373,00	€ 380,00

Setup costs custom colour treatment (frame)
 Setup costs for the first colour are € 225,00
 Setup costs for every next colour are € 75,00

Measurements

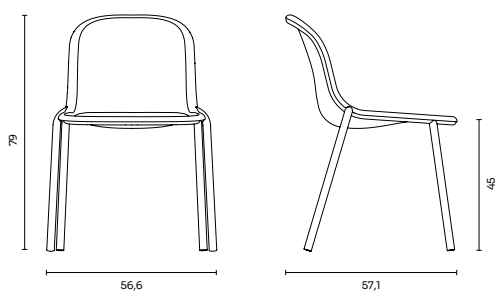

Upholstered seat



LJ 2 Stack Chair with upholstered seat

Specifications

Designed by
 Frame
 Standard frame colours

Shell
 PET Felt blends

Laurens van Wieringen
 Powder-coated steel
 Black (RAL 9011) / White (RAL 9010)
 with 70% gloss degree
 PET Felt
 Marine, Turquoise, Olive, Dark Green,
 Green, Yellow, Pink, Dark Grey, Light Grey,
 Brown, Beige

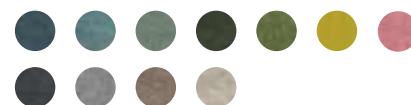

Upholstered seat

LJ 2 Stack Chair is also available with an upholstered seat. Please, find the surcharges on page 13.

Bespoke options

¹ Specified costs are based on custom RAL colours as shown in gloss degree 70%. Please, contact De Vorm for availability of the preferred colour. If the RAL colour is not in stock, there may be a price consequence.

² Specified costs are based on and only available in the following RAL fine texture colours: RAL 1012, RAL 3005, RAL 5008, RAL 5020, RAL 6007, RAL 6020, RAL 7015, RAL 7033, RAL 7044, RAL 7045, RAL 8014, RAL 9011.

*These colours match perfectly with our PET Felt blends.
 See page 81 for ton-sur-ton colour combinations.*

Additional information

PET Felt is made of recycled material. Slight colour deviations may appear between different products.

LJ Series

LJ 3 Bar Stool	Shell	Qty	Frame Black/White	Frame Custom Colour ¹	Frame Fine Texture ²
	Dark Grey, Light Grey	1	€ 308,00	€ 348,00	€ 355,00
	Colour blends	1	€ 342,00	€ 382,00	€ 388,00

Setup costs custom colour treatment (frame)
 Setup costs for the first colour are € 225,00
 Setup costs for every next colour are € 75,00

Measurements

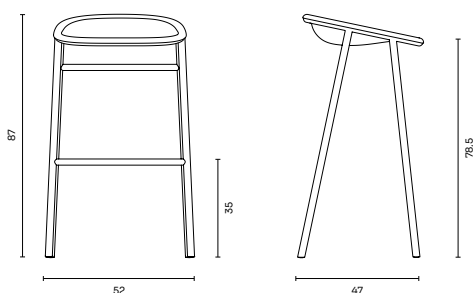

Upholstered seat



LJ 3 Bar Stool with upholstered seat

Specifications

Designed by
 Frame
 Standard frame colours

Shell
 PET Felt blends

Laurens van Wieringen
 Powder-coated steel
 Black (RAL 9011) / White (RAL 9010)
 with 70% gloss degree
 PET Felt
 Marine, Turquoise, Olive, Dark Green,
 Green, Yellow, Pink, Dark Grey, Light Grey,
 Brown, Beige

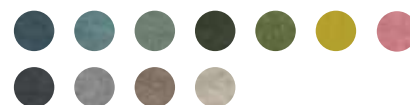

Upholstered seat

LJ 3 Bar Stool is also available with an upholstered seat. Please, find the surcharges on page 13.

Bespoke options

¹ Specified costs are based on custom RAL colours as shown in gloss degree 70%. Please, contact De Vorm for availability of the preferred colour. If the RAL colour is not in stock, there may be a price consequence.

² Specified costs are based on and only available in the following RAL fine texture colours: RAL 1012, RAL 3005, RAL 5008, RAL 5020, RAL 6007, RAL 6020, RAL 7015, RAL 7033, RAL 7044, RAL 7045, RAL 8014, RAL 9011.

*These colours match perfectly with our PET Felt blends.
 See page 81 for ton-sur-ton colour combinations.*

Additional information

PET Felt is made of recycled material. Slight colour deviations may appear between different products.

LJ Series

LJ 4 Counter Stool	Shell	Qty	Frame Black/White	Frame Custom Colour ¹	Frame Fine Texture ²
	Dark Grey, Light Grey	1	€ 308,00	€ 348,00	€ 355,00
	Colour blends	1	€ 342,00	€ 382,00	€ 388,00

Setup costs custom colour treatment (frame)
 Setup costs for the first colour are € 225,00
 Setup costs for every next colour are € 75,00

Measurements

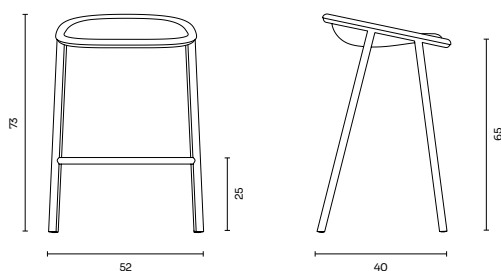

Upholstered seat



LJ 4 Counter Stool with upholstered seat

Specifications

Designed by
 Frame
 Standard frame colours

Shell
 PET Felt blends

Laurens van Wieringen
 Powder-coated steel
 Black (RAL 9011) / White (RAL 9010)
 with 70% gloss degree
 PET Felt
 Marine, Turquoise, Olive, Dark Green,
 Green, Yellow, Pink, Dark Grey, Light Grey,
 Brown, Beige

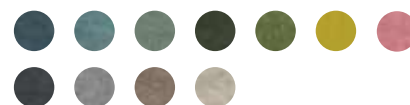

Upholstered seat

LJ 4 Counter Stool is also available with an upholstered seat.
 Please, find the surcharges on page 13.

Bespoke options

¹ Specified costs are based on custom RAL colours as shown in gloss degree 70%. Please, contact De Vorm for availability of the preferred colour. If the RAL colour is not in stock, there may be a price consequence.





² Specified costs are based on and only available in the following RAL fine texture colours: RAL 1012, RAL 3005, RAL 5008, RAL 5020, RAL 6007, RAL 6020, RAL 7015, RAL 7033, RAL 7044, RAL 7045, RAL 8014, RAL 9011.

*These colours match perfectly with our PET Felt blends.
 See page 81 for ton-sur-ton colour combinations.*

Additional information

PET Felt is made of recycled material. Slight colour deviations may appear between different products.

LJ Series

LJ Series Upholstered Seat	Qty	Fabric	Surcharge Ex. VAT
 LJ 1 Armchair with upholstered seat  LJ 2 Stack Chair with upholstered seat	1 - 9	A	€ 217,00
		B	€ 225,00
		C	€ 233,00
		D	€ 242,00
		E	€ 250,00
		F	€ 258,00
 LJ 3 Bar Stool with upholstered seat  LJ 4 Counter Stool with upholstered seat	10 - 24	A	€ 192,00
		B	€ 200,00
		C	€ 208,00
		D	€ 217,00
		E	€ 225,00
		F	€ 233,00
	25 - 49	A	€ 175,00
		B	€ 183,00
		C	€ 192,00
		D	€ 200,00
		E	€ 208,00
		F	€ 217,00
	> 50	A	€ 167,00
		B	€ 175,00
		C	€ 183,00
		D	€ 192,00
		E	€ 200,00
		F	€ 208,00

Find the overview of available fabrics on page 80.

Twist Series

Twist Stack Stool	Seat	Qty	Frame Black/White	Frame Custom Colour ¹	Frame Fine Texture ²
	Dark Grey, Light Grey	1	€ 225,00	€ 265,00	€ 272,00
	Colour blends	1	€ 233,00	€ 273,00	€ 280,00

Setup costs custom colour treatment (frame)
 Setup costs for the first colour are € 225,00
 Setup costs for every next colour are € 75,00

Measurements

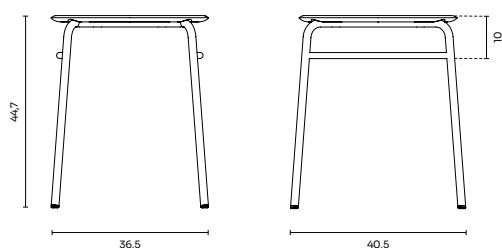

Upholstered seat



Twist Stack Stool with upholstered seat

Specifications

Designed by

Frame

Standard frame colours

Seat + backrest

PET Felt blends

De Vorm

Powder-coated steel

Black (RAL 9011) / White (RAL 9010)

with 70% gloss degree

PET Felt

Marine, Turquoise, Olive, Dark Green, Green, Yellow, Pink, Dark Grey, Light Grey, Brown, Beige

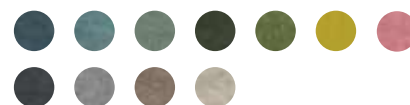

Upholstered seat

Twist Stack Stool is also available with an upholstered seat.

Please, find the surcharges on page 17.

Bespoke options

¹ Specified costs are based on custom RAL colours as shown in gloss degree 70%. Please, contact De Vorm for availability of the preferred colour. If the RAL colour is not in stock, there may be a price consequence.

² Specified costs are based on and only available in the following RAL fine texture colours: RAL 1012, RAL 3005, RAL 5008, RAL 5020, RAL 6007, RAL 6020, RAL 7015, RAL 7033, RAL 7044, RAL 7045, RAL 8014, RAL 9011.

These colours match perfectly with our PET Felt blends.

See page 81 for ton-sur-ton colour combinations.

Additional information

PET Felt is made of recycled material. Slight colour deviations may appear between different products.

Twist Series

Twist Counter Stool	Seat	Qty	Frame Black/White	Frame Custom Colour ¹	Frame Fine Texture ²
	Dark Grey, Light Grey	1	€ 258,00	€ 298,00	€ 305,00
	Colour blends	1	€ 275,00	€ 315,00	€ 322,00

Setup costs custom colour treatment (frame)
 Setup costs for the first colour are € 225,00
 Setup costs for every next colour are € 75,00

Measurements

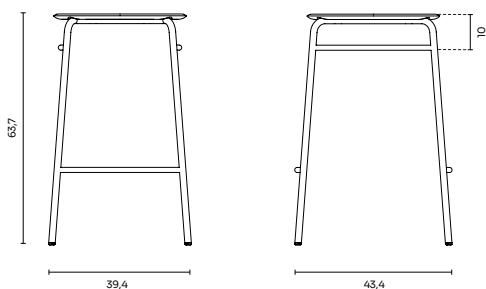

Upholstered seat



Twist Counter Stool with upholstered seat

Specifications

Designed by

Frame

Standard frame colours

Seat + backrest

PET Felt blends

De Vorm

Powder-coated steel

Black (RAL 9011) / White (RAL 9010)

with 70% gloss degree

PET Felt

Marine, Turquoise, Olive, Dark Green, Green, Yellow, Pink, Dark Grey, Light Grey, Brown, Beige

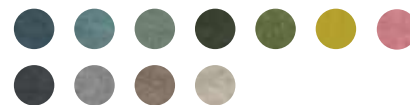

Upholstered seat

Twist Counter Stool is also available with an upholstered seat.

Please, find the surcharges on page 17.

Bespoke options

¹ Specified costs are based on custom RAL colours as shown in gloss degree 70%. Please, contact De Vorm for availability of the preferred colour. If the RAL colour is not in stock, there may be a price consequence.

² Specified costs are based on and only available in the following RAL fine texture colours: RAL 1012, RAL 3005, RAL 5008, RAL 5020, RAL 6007, RAL 6020, RAL 7015, RAL 7033, RAL 7044, RAL 7045, RAL 8014, RAL 9011.

These colours match perfectly with our PET Felt blends.

See page 81 for ton-sur-ton colour combinations.

Additional information

PET Felt is made of recycled material. Slight colour deviations may appear between different products.

Twist Series

Twist Bar Stool	Seat	Qty	Frame Black/White	Frame Custom Colour ¹	Frame Fine Texture ²
	Dark Grey, Light Grey	1	€ 258,00	€ 298,00	€ 305,00
	Colour blends	1	€ 275,00	€ 315,00	€ 322,00

Setup costs custom colour treatment (frame)
 Setup costs for the first colour are € 225,00
 Setup costs for every next colour are € 75,00

Measurements

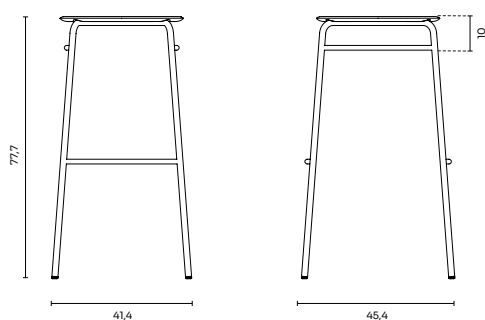

Upholstered seat



Twist Bar Stool with upholstered seat

Specifications

Designed by
 Frame
 Standard frame colours

Seat + backrest
 PET Felt blends

De Vorm
 Powder-coated steel
 Black (RAL 9011) / White (RAL 9010)
 with 70% gloss degree
 PET Felt
 Marine, Turquoise, Olive, Dark Green,
 Green, Yellow, Pink, Dark Grey, Light Grey,
 Brown, Beige

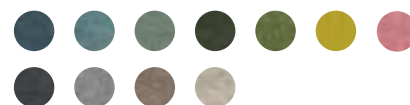

Upholstered seat

Twist Bar Stool is also available with an upholstered seat.
 Please, find the surcharges on page 17.

Bespoke options

¹ Specified costs are based on custom RAL colours as shown in gloss degree 70%. Please, contact De Vorm for availability of the preferred colour. If the RAL colour is not in stock, there may be a price consequence.



² Specified costs are based on and only available in the following RAL fine texture colours: RAL 1012, RAL 3005, RAL 5008, RAL 5020, RAL 6007, RAL 6020, RAL 7015, RAL 7033, RAL 7044, RAL 7045, RAL 8014, RAL 9011.

*These colours match perfectly with our PET Felt blends.
 See page 81 for ton-sur-ton colour combinations.*

Additional information

PET Felt is made of recycled material. Slight colour deviations may appear between different products.

Twist Series

Twist Series Upholstered Seat	Qty	Fabric	Surcharge Ex. VAT
 <p>Twist Stack Stool with upholstered seat</p>	1 - 9	A	€ 183,00
		B	€ 192,00
		C	€ 200,00
		D	€ 208,00
		E	€ 217,00
		F	€ 225,00
 <p>Twist Counter Stool with upholstered seat</p>	10 - 24	A	€ 158,00
		B	€ 167,00
		C	€ 175,00
		D	€ 183,00
		E	€ 192,00
		F	€ 200,00
 <p>Twist Bar Stool with upholstered seat</p>	25 - 49	A	€ 142,00
		B	€ 150,00
		C	€ 158,00
		D	€ 167,00
		E	€ 175,00
		F	€ 183,00
	> 50	A	€ 133,00
		B	€ 142,00
		C	€ 150,00
		D	€ 158,00
		E	€ 167,00
		F	€ 175,00

Find the overview of available fabrics on page 80.

Privacy Chairs

Privacy Chairs

Pod Privacy Chair



Shell	Fabric ¹	Frame Black/Clear ash	Frame Custom colour ²
Dark Grey, Light Grey	A	€ 3.325,00	€ 3.408,00
	B	€ 3.375,00	€ 3.458,00
	C	€ 3.417,00	€ 3.500,00
	D	€ 3.458,00	€ 3.542,00
	E	€ 3.500,00	€ 3.583,00
	F	€ 3.542,00	€ 3.625,00
Colour blends	A	€ 3.458,00	€ 3.542,00
	B	€ 3.500,00	€ 3.583,00
	C	€ 3.542,00	€ 3.625,00
	D	€ 3.583,00	€ 3.667,00
	E	€ 3.625,00	€ 3.708,00
	F	€ 3.667,00	€ 3.750,00

Setup costs custom colour treatment (frame)

Setup costs for the first colour are € 225,00

Setup costs for every next colour are € 75,00

Measurements

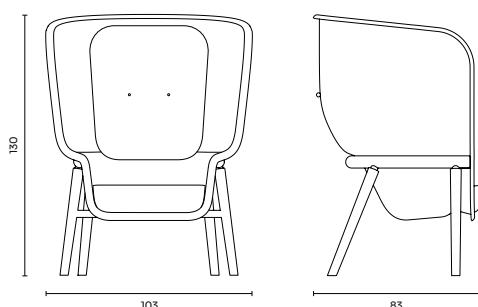

Specifications

Designed by

Benjamin Hubert

Frame

Solid ash

Standard frame colours

Black (RAL 9011) / White (RAL 9010)

with 70% gloss degree

Shell

PET Felt

PET Felt blends

Marine, Turquoise, Olive, Dark Green, Green, Yellow, Pink, Dark Grey, Light Grey, Brown, Beige

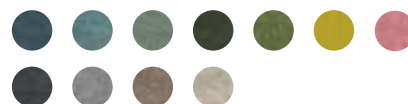

Bespoke options

¹ Find the overview of available fabrics on page 80.

² Specified costs are based on RAL colours as shown in gloss degree 30%. Please, contact De Vorm for availability of the preferred colour. If the RAL colour is not in stock, there may be a price consequence.

These colours match perfectly with our PET Felt blends.

See page 81 for ton-sur-ton colour combinations.

Additional information

PET Felt is made of recycled material. Slight colour deviations may appear between different products.

Lounge Chairs

Hale Lounge Chair

	Seat + Backrest	Qty	Frame Black/White	Frame Custom Colour ¹	Frame Fine Texture ²
Hale Lounge Chair 	Dark Grey, Light Grey	1	€ 408,00	€ 445,00	€ 455,00
	Colour blends	1	€ 442,00	€ 478,00	€ 488,00

Hale Lounge Chair Armrests 	Dark Grey, Light Grey	1	€ 458,00	€ 495,00	€ 505,00
	Colour blends	1	€ 475,00	€ 512,00	€ 522,00

Setup costs custom colour treatment (frame)
 Setup costs for the first colour are € 225,00
 Setup costs for every next colour are € 75,00

Measurements

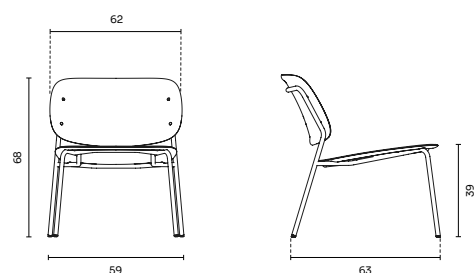

Upholstered seat



Hale Lounge Chair with upholstered seat



Hale Lounge Chair Armrests with upholstered seat

Specifications

Designed by
 Frame
 Standard frame colours

Seat + backrest
 PET Felt blends

De Vorm
 Powder-coated steel
 Black (RAL 9011) / White (RAL 9010)
 with 70% gloss degree
 PET Felt
 Marine, Turquoise, Olive, Dark Green,
 Green, Yellow, Pink, Dark Grey, Light Grey,
 Brown, Beige

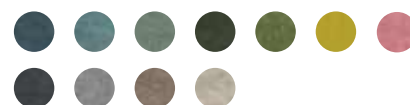

Upholstered seat

Hale Lounge Chair and Hale Lounge Chair Armrests are also available with an upholstered seat. Please, find the surcharges on page 21.

Bespoke options

¹ Specified costs are based on custom RAL colours as shown in gloss degree 70%. Please, contact De Vorm for availability of the preferred colour. If the RAL colour is not in stock, there may be a price consequence.

² Specified costs are based on and only available in the following RAL fine texture colours: RAL 1012, RAL 3005, RAL 5008, RAL 5020, RAL 6007, RAL 6020, RAL 7015, RAL 7033, RAL 7044, RAL 7045, RAL 8014, RAL 9011.

*These colours match perfectly with our PET Felt blends.
 See page 81 for ton-sur-ton colour combinations.*

Additional information

PET Felt is made of recycled material. Slight colour deviations may appear between different products.

Hale Lounge Chair

Hale Lounge Chair Upholstered Seat



Hale Lounge Chair
with upholstered seat



Hale Lounge Chair
Armrests with
upholstered seat

Qty	Fabric	Surcharge Ex. VAT
1 - 9	A	€ 256,00
	B	€ 264,00
	C	€ 273,00
	D	€ 281,00
	E	€ 289,00
	F	€ 298,00
10 - 24	A	€ 231,00
	B	€ 240,00
	C	€ 248,00
	D	€ 256,00
	E	€ 264,00
	F	€ 273,00
25 - 49	A	€ 215,00
	B	€ 223,00
	C	€ 231,00
	D	€ 240,00
	E	€ 248,00
	F	€ 256,00
> 50	A	€ 207,00
	B	€ 215,00
	C	€ 223,00
	D	€ 231,00
	E	€ 240,00
	F	€ 248,00

Find the overview of available fabrics on page 80.

Nook Lounge Chair

Nook Lounge Chair	Shell	Fabric ¹	Frame Black/White	Frame Custom colour ²	Frame Fine texture ³	
	Dark Grey, Light Grey	Upon request	A	-	-	-
		B	€ 1.325,00	€ 1.340,00	€ 1.359,00	
		C	€ 1.408,00	€ 1.423,00	€ 1.443,00	
		D	€ 1.425,00	€ 1.440,00	€ 1.459,00	
		E	€ 1.442,00	€ 1.457,00	€ 1.476,00	
		F	€ 1.458,00	€ 1.473,00	€ 1.493,00	
		G	€ 1.492,00	€ 1.507,00	€ 1.526,00	
		H	€ 1.625,00	€ 1.640,00	€ 1.659,00	
	Colour blends	Upon request	A	-	-	-
		B	€ 1.408,00	€ 1.423,00	€ 1.443,00	
		C	€ 1.492,00	€ 1.507,00	€ 1.526,00	
		D	€ 1.508,00	€ 1.523,00	€ 1.543,00	
		E	€ 1.525,00	€ 1.540,00	€ 1.559,00	
		F	€ 1.542,00	€ 1.557,00	€ 1.576,00	
		G	€ 1.575,00	€ 1.590,00	€ 1.609,00	
		H	€ 1.708,00	€ 1.723,00	€ 1.743,00	

Setup costs custom colour treatment (frame)

Setup costs for the first colour are € 225,00

Setup costs for every next colour are € 75,00

Measurements

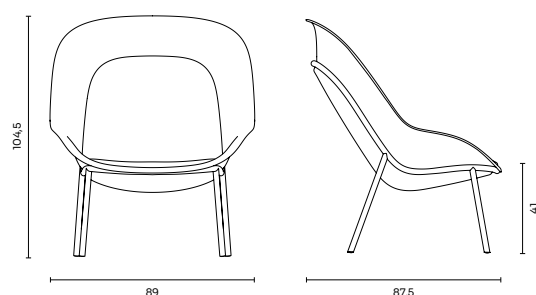

Specifications

Designed by

Johan van Hengel

Frame

Powder-coated steel

Standard frame colours

Black (RAL 9011) / White (RAL 9010)

with 70% gloss degree

Shell

PET Felt

PET Felt blends

Marine, Turquoise, Olive, Dark Green, Green, Yellow, Pink, Dark Grey, Light Grey, Brown, Beige



Bespoke options

¹ Find the overview of available fabrics on page 80.

² Specified costs are based on RAL colours as shown in gloss degree 30%.

Please, contact De Vorm for availability of the preferred colour.

If the RAL colour is not in stock, there may be a price consequence.

³ Specified costs are based on and only available in the following RAL fine texture colours: RAL 1012, RAL 3005, RAL 5008, RAL 5020, RAL 6007, RAL

6020, RAL 7015, RAL 7033, RAL 7044, RAL 7045, RAL 8014, RAL 9011.

These colours match perfectly with our PET Felt blends.

See page 81 for ton-sur-ton colour combinations.

Additional information

PET Felt is made of recycled material. Slight colour deviations may appear between different products.

Daddy's Lounge Chair

Daddy's Lounge Chair	Qty	Fabric ¹	Armrests Clear oak / Walnut	Armrests Custom colour ²
	1	A	€ 2.125,00	€ 2.208,00
		B	€ 2.208,00	€ 2.292,00
		C	€ 2.292,00	€ 2.375,00
		D	€ 2.375,00	€ 2.458,00
		E	€ 2.458,00	€ 2.542,00
		F	€ 2.500,00	€ 2.583,00
		G	€ 2.583,00	€ 2.667,00
		H	€ 2.750,00	€ 2.833,00

Measurements

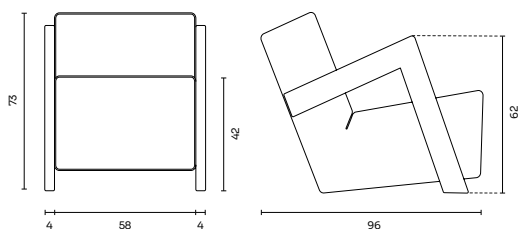

Specifications

Designed by	De Vorm
Frame	Solid oak or walnut
Body	Upholstered

Bespoke options

¹ Find the overview of available fabrics on page 80.

² Specified costs are based on RAL colours as shown in gloss degree 30%. Please, contact De Vorm for availability of the preferred colour. If the RAL colour is not in stock, there may be a price consequence.

Couches

Arnhem Series

	Fabric ¹	Ex. VAT
Arnhem Sofa 71 	A	€ 4.463,00
	B	€ 4.628,00
	C	€ 4.793,00
	D	€ 4.959,00
	E	€ 5.124,00
	F	€ 5.289,00
Arnhem Sofa 94 	A	€ 4.959,00
	B	€ 5.124,00
	C	€ 5.289,00
	D	€ 5.455,00
	E	€ 5.785,00
	F	€ 6.281,00
Arnhem Sofa 118 	A	€ 5.455,00
	B	€ 5.785,00
	C	€ 5.950,00
	D	€ 6.116,00
	E	€ 6.281,00
	F	€ 6.612,00
Arnhem Sofa 141 	A	€ 5.785,00
	B	€ 5.950,00
	C	€ 6.116,00
	D	€ 6.281,00
	E	€ 6.777,00
	F	€ 7.107,00

Measurements

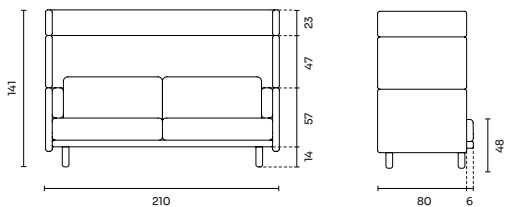

Arnhem Series Legs



Solid oak /
solid ash legs

Sled legs

Angled legs

Specifications

Designed by	Sebastian Herkner
Body + cushions	Upholstered
Legs	Solid oak or ash, clear-lacquered –
	Sled (Powder-coated steel, Black RAL 9011) € 331,00
	Angled (Powder-coated steel, Black RAL 9011) € 413,00

Bespoke options

The colour of the legs can be customised.





Extra costs for custom colour treatment per set of 4 solid wooden oak or ash legs are € 25,00 ex VAT.

Extra costs for colour treatment per set of the angled or sled legs are € 75,00 ex VAT. Specified costs are based on RAL colours as shown in gloss degree 70%. Please, contact De Vorm for availability of the preferred colour. If the RAL colour is not on stock, there can be a price consequence.

Additional information

Find the overview of available fabrics on page 80. The prices in this list are based on ordering Arnhem Sofa in one fabric type in one or two colours. For prices of other combinations, please, contact De Vorm.

Arnhem Series

		Fabric ¹	Ex. VAT
Arnhem Loveseat 71		A	€ 3.250,00
		B	€ 3.375,00
		C	€ 3.500,00
		D	€ 3.625,00
		E	€ 3.875,00
		F	€ 4.208,00
Arnhem Loveseat 94		A	€ 3.917,00
		B	€ 4.083,00
		C	€ 4.250,00
		D	€ 4.417,00
		E	€ 4.583,00
		F	€ 4.917,00
Arnhem Loveseat 118		A	€ 4.333,00
		B	€ 4.500,00
		C	€ 4.667,00
		D	€ 4.833,00
		E	€ 5.000,00
		F	€ 5.333,00
Arnhem Loveseat 141		A	€ 4.417,00
		B	€ 4.750,00
		C	€ 5.083,00
		D	€ 5.417,00
		E	€ 5.500,00
		F	€ 5.667,00

Measurements

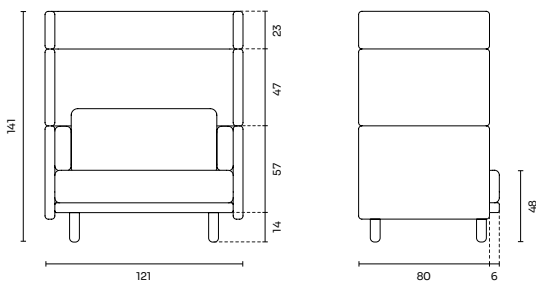

Arnhem Series Legs



Solid oak /
solid ash legs



Sled legs



Angled legs

Specifications

Designed by	Sebastian Herkner
Body + cushions	Upholstered
Legs	Solid oak or ash, clear-lacquered –
	Sled (Powder-coated steel, Black RAL 9011) € 331,00
	Angled (Powder-coated steel, Black RAL 9011) € 413,00

Bespoke options

The colour of the legs can be customised.

Extra costs for custom colour treatment per set of 4 solid wooden oak or ash legs are € 25,00 ex VAT.

Extra costs for colour treatment per set of the angled or sled legs are € 75,00 ex VAT. Specified costs are based on RAL colours as shown in gloss degree 70%. Please, contact De Vorm for availability of the preferred colour. If the RAL colour is not on stock, there can be a price consequence.

Additional information

Find the overview of available fabrics on page 80. The prices in this list are based on ordering Arnhem Sofa in one fabric type in one or two colours. For prices of other combinations, please, contact De Vorm.

Arnhem Series

		Fabric ¹	Ex. VAT
Arnhem Sofa Goes Room 71 	A	€	4.167,00
	B	€	4.417,00
	C	€	4.583,00
	D	€	4.750,00
	E	€	4.917,00
	F	€	5.500,00
Arnhem Sofa Goes Room 94 	A	€	4.750,00
	B	€	5.083,00
	C	€	5.250,00
	D	€	5.417,00
	E	€	5.583,00
	F	€	6.333,00
Arnhem Sofa Goes Room 118 	A	€	5.167,00
	B	€	5.583,00
	C	€	5.833,00
	D	€	6.000,00
	E	€	6.333,00
	F	€	7.000,00
Arnhem Sofa Goes Room 141 	A	€	5.750,00
	B	€	6.250,00
	C	€	6.500,00
	D	€	6.750,00
	E	€	7.000,00
	F	€	7.833,00

Measurements

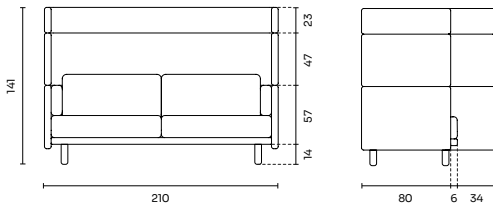

Arnhem Series Legs



Solid oak / solid ash legs

Sled legs

Angled legs

Specifications

Designed by	Sebastian Herkner
Body + cushions	Upholstered
Legs	Solid oak or ash, clear-lacquered –
	Sled (Powder-coated steel, Black RAL 9011) € 331,00
	Angled (Powder-coated steel, Black RAL 9011) € 413,00

Bespoke options

The colour of the legs can be customised.





Extra costs for custom colour treatment per set of 4 solid wooden oak or ash legs are € 25,00 ex VAT.

Extra costs for colour treatment per set of the angled or sled legs are € 75,00 ex VAT. Specified costs are based on RAL colours as shown in gloss degree 70%. Please, contact De Vorm for availability of the preferred colour. If the RAL colour is not on stock, there can be a price consequence.

Additional information

Find the overview of available fabrics on page 80. The prices in this list are based on ordering Arnhem Sofa in one fabric type in one or two colours. For prices of other combinations, please, contact De Vorm.

Arnhem Series

		Fabric ¹	Ex. VAT
Arnhem Loveseat Goes Room 71		A	€ 3.417,00
		B	€ 3.500,00
		C	€ 3.583,00
		D	€ 3.667,00
		E	€ 3.750,00
		F	€ 4.125,00
Arnhem Loveseat Goes Room 94		A	€ 3.958,00
		B	€ 4.125,00
		C	€ 4.292,00
		D	€ 4.458,00
		E	€ 4.625,00
		F	€ 4.792,00
Arnhem Loveseat Goes Room 118		A	€ 4.208,00
		B	€ 4.375,00
		C	€ 4.542,00
		D	€ 4.708,00
		E	€ 4.875,00
		F	€ 5.042,00
Arnhem Loveseat Goes Room 141		A	€ 4.708,00
		B	€ 4.875,00
		C	€ 5.042,00
		D	€ 5.208,00
		E	€ 5.375,00
		F	€ 5.542,00

Measurements

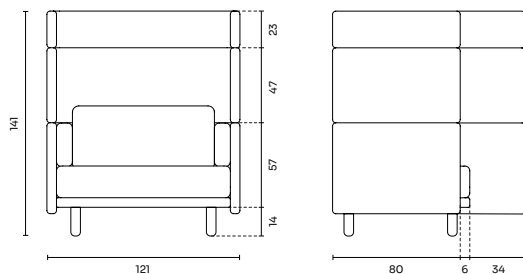

Arnhem Series Legs



Solid oak /
solid ash legs

Sled legs

Angled legs

Specifications

Designed by	Sebastian Herkner
Body + cushions	Upholstered
Legs	Solid oak or ash, clear-lacquered –
	Sled (Powder-coated steel, Black RAL 9011) € 331,00
	Angled (Powder-coated steel, Black RAL 9011) € 413,00

Bespoke options

The colour of the legs can be customised.

Extra costs for custom colour treatment per set of 4 solid wooden oak or ash legs are € 25,00 ex VAT.

Extra costs for colour treatment per set of the angled or sled legs are € 75,00 ex VAT. Specified costs are based on RAL colours as shown in gloss degree 70%. Please, contact De Vorm for availability of the preferred colour. If the RAL colour is not on stock, there can be a price consequence.

Additional information

Find the overview of available fabrics on page 80. The prices in this list are based on ordering Arnhem Sofa in one fabric type in one or two colours. For prices of other combinations, please, contact De Vorm.

Upside Down Series

	Fabric ¹	Ex. VAT
Upside Down Couch 205 	A	€ 4.000,00
	B	€ 4.167,00
	C	€ 4.333,00
	D	€ 4.500,00
	E	€ 4.667,00
	F	€ 4.833,00
Upside Down Couch 235 	A	€ 4.167,00
	B	€ 4.417,00
	C	€ 4.583,00
	D	€ 4.750,00
	E	€ 4.917,00
	F	€ 5.083,00
Upside Down Couch 265 	A	€ 4.500,00
	B	€ 4.667,00
	C	€ 4.833,00
	D	€ 5.000,00
	E	€ 5.167,00
	F	€ 5.333,00

Measurements

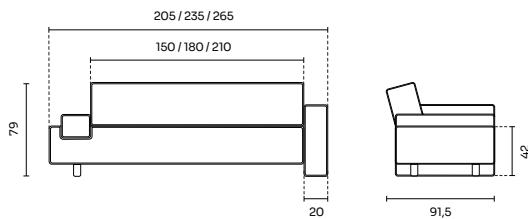

Specifications

Designed by	De Vorm	
Body + cushions	Upholstered	
Legs	Solid oak or walnut, clear-lacquered	€ 142,00
Plinth	Upholstered	€ 375,00

Bespoke options

The colour of the legs can be customised. Extra costs for custom colour treatment per set of legs are € 25,00 ex VAT. Specified costs are based on RAL colours as shown in gloss degree 70%. Please, contact De Vorm for availability of the preferred colour. If the RAL colour is not in stock, there may be a price consequence.

Additional information

The prices in this list are based on ordering Upside Down Couch in one colour or with the rotatable armrest in a different colour of the same fabric type. For prices of other combinations, please, contact De Vorm.

Upside Down Legs

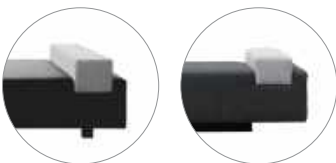

Legs

Plinth

Upside Down Series

	Fabric ¹	Ex. VAT
Upside Down Couch Island 185	A	€ 2.833,00
	B	€ 2.917,00
	C	€ 3.000,00
	D	€ 3.083,00
	E	€ 3.167,00
	F	€ 3.250,00
Upside Down Couch Island 215	A	€ 3.000,00
	B	€ 3.083,00
	C	€ 3.167,00
	D	€ 3.250,00
	E	€ 3.333,00
	F	€ 3.417,00
Upside Down Couch Island 245	A	€ 3.167,00
	B	€ 3.250,00
	C	€ 3.333,00
	D	€ 3.417,00
	E	€ 3.500,00
	F	€ 3.583,00

Measurements

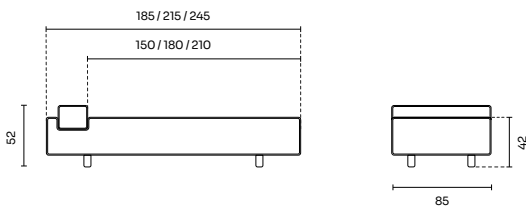

Upside Down Legs

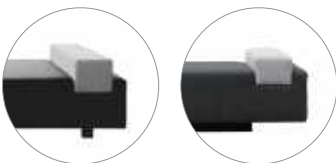

Legs

Plinth

Specifications

Designed by	De Vorm	
Body + cushions	Upholstered	
Legs	Solid oak or walnut, clear-lacquered	€ 225,00
Plinth	Upholstered	€ 375,00

Bespoke options

The colour of the legs can be customised. Extra costs for custom colour treatment per set of legs are € 25,00 ex VAT. Specified costs are based on RAL colours as shown in gloss degree 70%. Please, contact De Vorm for availability of the preferred colour. If the RAL colour is not in stock, there may be a price consequence.

Additional information

The prices in this list are based on ordering Upside Down Couch in one colour or with the rotatable armrest in a different colour of the same fabric type. For prices of other combinations, please, contact De Vorm.

Florian Series

	Qty.	Fabric ¹	Frame Black	Frame Custom colour ²	Frame Fine texture ³
Florian Chair 	1	A	€ 775,00	€ 900,00	€ 942,00
		B	€ 808,00	€ 933,00	€ 975,00
		C	€ 842,00	€ 967,00	€ 1.008,00
		D	€ 875,00	€ 1.000,00	€ 1.042,00
		E	€ 908,00	€ 1.033,00	€ 1.075,00
		F	€ 942,00	€ 1.067,00	€ 1.108,00
		G	€ 975,00	€ 1.100,00	€ 1.142,00
		H	€ 1.075,00	€ 1.200,00	€ 1.242,00

Florian Bench 	1	A	€ 1.208,00	€ 1.333,00	€ 1.375,00
		B	€ 1.242,00	€ 1.367,00	€ 1.408,00
		C	€ 1.275,00	€ 1.400,00	€ 1.442,00
		D	€ 1.308,00	€ 1.433,00	€ 1.475,00
		E	€ 1.342,00	€ 1.467,00	€ 1.508,00
		F	€ 1.375,00	€ 1.500,00	€ 1.542,00
		G	€ 1.408,00	€ 1.533,00	€ 1.575,00
		H	€ 1.658,00	€ 1.783,00	€ 1.825,00

Measurements Florian Chair

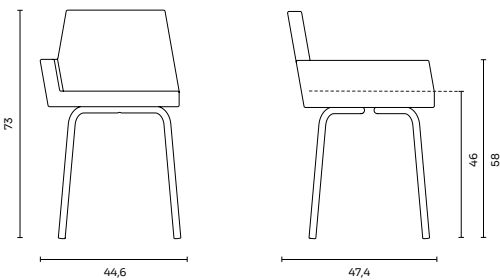

Measurements Florian Bench

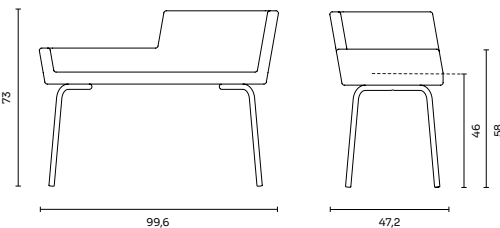

Specifications

Designed by **Laurens van Wieringen**
 Frame **Powder-coated steel**
 Standard frame colours **Black (RAL 9011) / White (RAL 9010)**
 with 70% gloss degree
 Body **Upholstered**

Bespoke options¹ Find the overview of available fabrics on page 80.

² Specified costs are based on custom RAL colours as shown in gloss degree 70%. Please, contact De Vorm for availability of the preferred colour. If the RAL colour is not in stock, there may be a price consequence.

³ Specified costs are based on and only available in the following RAL fine texture colours: RAL 1012, RAL 3005, RAL 5008, RAL 5020, RAL 6007, RAL 6020, RAL 7015, RAL 7033, RAL 7044, RAL 7045, RAL 8014, RAL 9011.

Mino Sofa Modular System

Configuration options

Mino One



Mino Two

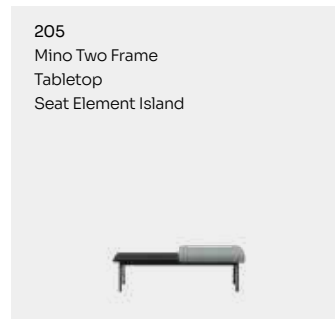

Mino Three

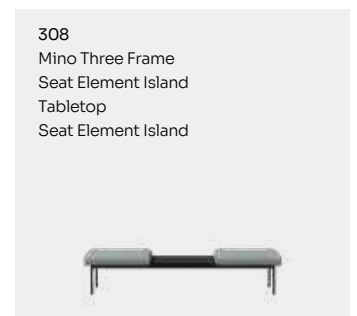
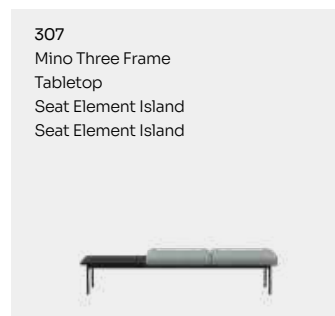
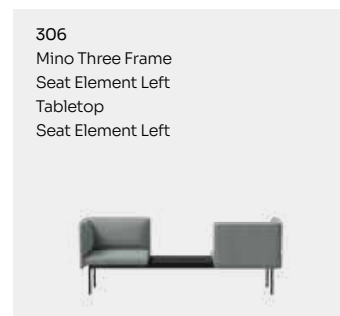
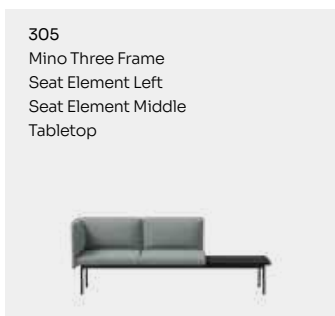
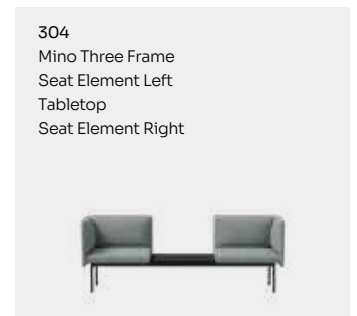
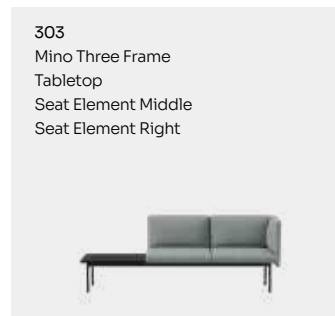
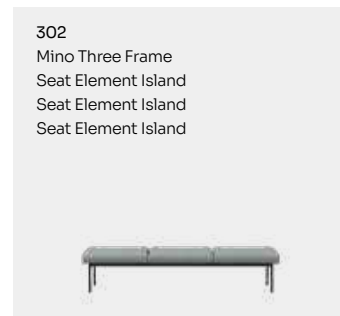
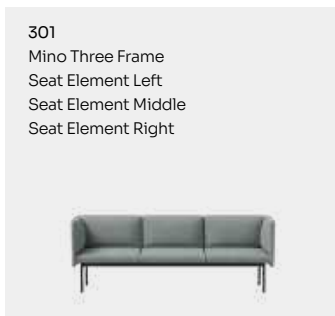

Mino Sofa Modular System

Mino Four

401
Mino Four Frame
Seat Element Left
Seat Element Middle
Seat Element Middle
Seat Element Right



402
Mino Four Frame
Seat Element Island
Seat Element Island
Seat Element Island
Seat Element Island



403
Mino Four Frame
Tabletop
Seat Element Middle
Seat Element Island
Seat Element Right



404
Mino Four Frame
Seat Element Left
Tabletop
Seat Element Middle
Seat Element Right



405
Mino Four Frame
Seat Element Left
Seat Element Middle
Tabletop
Seat Element Right



406
Mino Four Frame
Seat Element Left
Seat Element Middle
Seat Element Middle
Tabletop



407
Mino Four Frame
Tabletop
Seat Element Middle
Seat Element Middle
Tabletop



408
Mino Four Frame
Seat Element Right
Tabletop
Seat Element Middle
Seat Element Right



409
Mino Four Frame
Seat Element Left
Seat Element Middle
Tabletop
Seat Element Left



410
Mino Four Frame
Tabletop
Seat Element Island
Seat Element Island
Seat Element Island



411
Mino Four Frame
Seat Element Island
Tabletop
Seat Element Island
Seat Element Island



412
Mino Four Frame
Tabletop
Seat Element Island
Seat Element Island
Tabletop



413
Mino Four Frame
Seat Element Left
Seat Element Middle
Tabletop
Seat Element Island





414
Mino Four Frame
Seat Element Island
Tabletop
Seat Element Middle
Seat Element Right







Mino Sofa Modular System

Mino Five

<p>501 Mino Five Frame Seat Element Left Seat Element Middle Seat Element Middle Seat Element Middle Seat Element Right</p> 	<p>502 Mino Five Frame Seat Element Island Seat Element Island Seat Element Island Seat Element Island Seat Element Island</p> 	<p>503 Mino Five Frame Tabletop Seat Element Middle Seat Element Middle Seat Element Middle Seat Element Right</p> 	<p>504 Mino Five Frame Seat Element Left Tabletop Seat Element Middle Seat Element Middle Seat Element Right</p> 
<p>505 Mino Five Frame Seat Element Left Seat Element Middle Tabletop Seat Element Middle Seat Element Right</p> 	<p>506 Mino Five Frame Seat Element Left Seat Element Middle Seat Element Middle Tabletop Seat Element Right</p> 	<p>507 Mino Five Frame Seat Element Left Seat Element Middle Seat Element Middle Seat Element Middle Tabletop</p> 	<p>508 Mino Five Frame Seat Element Left Tabletop Seat Element Middle Tabletop Seat Element Right</p> 
<p>509 Mino Five Frame Tabletop Seat Element Middle Seat Element Middle Seat Element Middle Tabletop</p> 	<p>510 Mino Five Frame Seat Element Right Seat Element Middle Tabletop Seat Element Middle Seat Element Right</p> 	<p>511 Mino Five Frame Tabletop Seat Element Island Seat Element Island Seat Element Island Seat Element Island</p> 	<p>512 Mino Five Frame Seat Element Island Tabletop Seat Element Island Seat Element Island Seat Element Island</p> 
<p>513 Mino Five Frame Seat Element Island Seat Element Island Tabletop Seat Element Island Seat Element Island</p> 	<p>514 Mino Five Frame Seat Element Island Tabletop Seat Element Island Tabletop Seat Element Island</p> 		

Mino Sofa Modular System

Frames	Frame Black	Frame Custom colour ¹	Frame Fine texture ²
Mino One Frame	€ 392,00	€ 442,00	€ 467,00
			
Mino Two Frame	€ 492,00	€ 542,00	€ 567,00
			
Mino Three Frame	€ 625,00	€ 700,00	€ 725,00
			
Mino Four Frame	€ 992,00	€ 1.092,00	€ 1.117,00
			
Mino Five Frame	€ 1.208,00	€ 1.333,00	€ 1.358,00
			

Setup costs custom colour treatment (frame)

Setup costs for the first colour are € 225,00

Setup costs for every next colour are € 75,00

Specifications

Designed by

KLINGER BORDIHN + De Vorm





Standard frame colour

Black (RAL 9011) with 70% gloss degree

¹ Specified costs are based on custom RAL colours as shown in gloss degree 70%. Please, contact De Vorm for availability of the preferred colour. If the RAL colour is not in stock, there may be a price consequence.

² Specified costs are based on and only available in the following RAL fine texture colours: RAL 1012, RAL 3005, RAL 5008, RAL 5020, RAL 6007, RAL 6020, RAL 7015, RAL 7033, RAL 7044, RAL 7045, RAL 8014, RAL 9011.

Mino Sofa Modular System

Seat elements		Fabric ¹	Ex. VAT
Mino Seat Element Left		A	€ 1.042,00
		B	€ 1.208,00
		C	€ 1.458,00
		D	€ 1.542,00
		E	€ 1.625,00
		F	€ 1.825,00
Mino Seat Element Middle		A	€ 1.042,00
		B	€ 1.208,00
		C	€ 1.458,00
		D	€ 1.542,00
		E	€ 1.625,00
		F	€ 1.825,00
Mino Seat Element Right		A	€ 792,00
		B	€ 958,00
		C	€ 1.042,00
		D	€ 1.125,00
		E	€ 1.208,00
		F	€ 1.333,00
Mino Seat Element One Seat		A	€ 1.292,00
		B	€ 1.542,00
		C	€ 1.792,00
		D	€ 1.958,00
		E	€ 2.208,00
		F	€ 2.375,00
Mino Seat Element Island		A	€ 433,00
		B	€ 517,00
		C	€ 558,00
		D	€ 600,00
		E	€ 642,00
		F	€ 725,00

Specifications





Designed by

KLINGER BORDIHN + De Vorm

Bespoke options

¹ Find the overview of available fabrics on page 80.

Mino Sofa Modular System

Add-ons		Frame Black	Frame Custom colour ¹	Frame Fine texture ²
Mino Electrification Unit Bachmann Pix 230V RA		€ 233,00	€ 250,00	€ 258,00
Mino Side Table	 	A € 242,00 B € 225,00	€ 258,00 € 242,00	€ 267,00 € 250,00
Mino Tabletop	 	A € 300,00 B € 233,00		

Specifications

Designed by **KLINGER BORDIHN + De Vorm**
Standard frame colour **Black (RAL 9011) with 70% gloss degree**

Bespoke options

Standard tabletops **A. MDF core + Oak veneer top layer
B. Black MDF core + Fenix NTM 0720 top layer**
Tabletop thickness **Side Table: 19 mm**
Tabletop: 28 mm

¹ Specified costs are based on custom RAL colours as shown in gloss degree 70%. Please, contact De Vorm for availability of the preferred colour. If the RAL colour is not in stock, there may be a price consequence.

² Specified costs are based on and only available in the following RAL fine texture colours: RAL 1012, RAL 3005, RAL 5008, RAL 5020, RAL 6007, RAL 6020, RAL 7015, RAL 7033, RAL 7044, RAL 7045, RAL 8014, RAL 9011.

The tabletop is also available in other HPL, Forbo, Fenix or veneer finishes. Please, contact De Vorm for more information about available options.

Additional information

The MDF core of Mino Tables is CARB II certified.

Tables

Big Modular Table System



Prices as mentioned on the right are indications based on the smallest length and depth, a 28 mm MDF core with an HPL Duropal U11026 finish, straight edges, a matching edgeband and rounded corners with 60 mm radius.

Exact prices depend on length, width, height, finish of the tabletop and the ordered quantity.

Please, contact De Vorm for the exact quotation.

Note

For tables with a length of 160 – 297 cm and a width less than 131 cm, see our Lite Modular Table System.

Length	Width	Big 74	Big 95	Big 110
160 – 219	130 – 200	€ 2.291,00	€ 2.361,00	€ 2.416,00
220 – 279	130 – 200	€ 2.605,00	€ 2.675,00	€ 2.730,00
280 – 297	130 – 200	€ 3.726,00	€ 3.796,00	€ 3.851,00
298 – 339	90 – 200	€ 3.159,00	€ 3.230,00	€ 3.285,00
340 – 399	90 – 200	€ 3.391,00	€ 3.461,00	€ 3.516,00
400 – 459	90 – 200	€ 3.723,00	€ 3.794,00	€ 3.849,00
460 – 519	90 – 200	€ 3.986,00	€ 4.056,00	€ 4.111,00
520 – 579	90 – 200	€ 4.623,00	€ 4.729,00	€ 4.811,00
580 – 639	90 – 200	€ 5.251,00	€ 5.356,00	€ 5.439,00
640 – 699	90 – 200	€ 5.621,00	€ 5.726,00	€ 5.809,00
700 – 759	90 – 200	€ 5.867,00	€ 5.972,00	€ 6.055,00
760 – 819	90 – 200	€ 6.155,00	€ 6.261,00	€ 6.343,00
820 – 879	90 – 200	€ 6.709,00	€ 6.814,00	€ 6.897,00
880 – 939	90 – 200	€ 7.559,00	€ 7.700,00	€ 7.810,00
940 – 1000	90 – 200	€ 7.771,00	€ 7.911,00	€ 8.021,00

Leg options

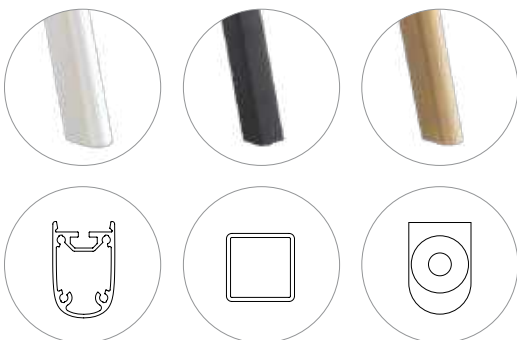

Anodised legs

Steel legs

Solid Oak legs

Specifications

Standard frame & legs
Height

Anodised aluminium (VOM1 Natural)
74 / 95 / 110 cm

Bespoke options

- De Vorm offers the possibility to customise the legs of the Big Table:
 - Solid oak legs for Big Round 74 no surcharge
 - Powder-coated steel legs, Black (RAL 9011) no surcharge
 - Anodised or steel legs in custom RAL colour* € 40,00
 - Anodised or steel legs in Fine texture* € 50,00

Fine texture is only available in the following RAL colours:
RAL 1012, RAL 3005, RAL 5008, RAL 5020, RAL 6007,
RAL 6020, RAL 7015, RAL 7033, RAL 7044, RAL 7045,
RAL 8014, RAL 9011.

 - * Setup costs for the first custom colour: € 225,00
 - Setup costs for every next custom colour: € 75,00

2. De Vorm offers a variety of tabletop options:

- 28 mm MDF core + HPL, veneer, Fenix or Desktop top layer
- 27 mm Plywood core + HPL, veneer, Fenix or Desktop top layer
- Diverse edge finishes

Please, contact De Vorm for more information about available options.

3. Tabletop can be equipped with cable cubbies. Find our standard cable cubby options on page 43.

Big Round Modular Table System



Prices as mentioned on the right are indications based on the smallest length and depth, a 28mm MDF core with an HPL Duropal U11026 finish, straight edges, and a matching edgeband.

Prices depend on the diameter, finish of the tabletop and the ordered quantity.

Please, contact De Vorm for the exact quotation.

Note

For tables with a diameter of 120 – 159 cm, see our Lite Round Modular Table System.

Ø Tabletop	Big Round 74	Big Round 95	Big Round 110
160	€ 3.233,00	€ 3.315,00	€ 3.375,00
170	€ 3.270,00	€ 3.352,00	€ 3.412,00
180	€ 3.307,00	€ 3.389,00	€ 3.449,00
190	€ 3.440,00	€ 3.522,00	€ 3.582,00
200	€ 3.672,00	€ 3.755,00	€ 3.815,00
210	€ 3.953,00	€ 4.035,00	€ 4.095,00
220	€ 3.994,00	€ 4.076,00	€ 4.136,00
230	€ 4.267,00	€ 4.349,00	€ 4.409,00
240	€ 4.310,00	€ 4.393,00	€ 4.453,00
250	€ 4.613,00	€ 4.696,00	€ 4.756,00

Leg options



Anodised legs

Steel legs

Solid Oak legs

Specifications

Standard frame & legs
Height

Anodised aluminium (VOM1 Natural)
74 / 95 / 110 cm

Bespoke options

- De Vorm offers the possibility to customise the legs of the Big Table:
 - Solid oak legs for Big 74 no surcharge
 - Powder-coated steel legs, Black (RAL 9011) no surcharge
 - Anodised or steel legs in custom RAL colour* € 40,00
 - Anodised or steel legs in Fine texture* € 50,00

Fine texture is only available in the following RAL colours:
RAL 1012, RAL 3005, RAL 5008, RAL 5020, RAL 6007,
RAL 6020, RAL 7015, RAL 7033, RAL 7044, RAL 7045,
RAL 8014, RAL 9011.

 - * Setup costs for the first custom colour: € 225,00
 - Setup costs for every next custom colour: € 75,00

2. De Vorm offers a variety of tabletop options:

- 28 mm MDF core + HPL, veneer, Fenix or Desktop top layer
- 27 mm Plywood core + HPL, veneer, Fenix or Desktop top layer
- Diverse edge finishes

Please, contact De Vorm for more information about available options.

3. Tabletop can be equipped with cable cubbies. Find our standard cable cubby options on page 43.

Lite Modular Table System



Prices as mentioned on the right are indications based on the smallest length and depth, a 28mm MDF core with an HPL Duropal U11026 finish, straight edges, a matching edgeband and rounded corners with 60 mm radius.

Prices depend on length, width, height, finish of the tabletop and the ordered quantity.

Please, contact De Vorm for the exact quotation.

Length	Width	Lite 74	Lite 95	Lite 110
150 – 179	90 – 129	€ 1.642,00	€ 1.686,00	€ 1.725,00
180 – 209	90 – 129	€ 1.697,00	€ 1.741,00	€ 1.780,00
210 – 239	90 – 129	€ 1.868,00	€ 1.913,00	€ 1.951,00
240 – 269	90 – 129	€ 1.912,00	€ 1.957,00	€ 1.995,00
270 – 297	90 – 129	€ 2.073,00	€ 2.118,00	€ 2.157,00

Leg options

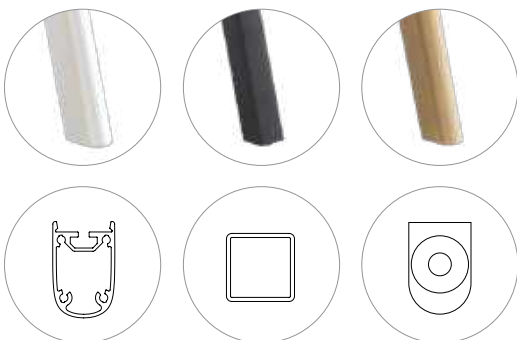

Anodised legs

Steel legs

Solid Oak legs

Specifications

Standard frame & legs
Height

Anodised aluminium (VOM1 Natural)
74 / 95 / 110 cm

Bespoke options

- De Vorm offers the possibility to customise the legs of the Lite Table:
 - Solid oak legs for Lite 74 no surcharge
 - Powder-coated steel legs, Black (RAL 9011) no surcharge
 - Anodised or steel legs in custom RAL colour* € 40,00
 - Anodised or steel legs in Fine texture* € 50,00

Fine texture is only available in the following RAL colours:
RAL 1012, RAL 3005, RAL 5008, RAL 5020, RAL 6007,
RAL 6020, RAL 7015, RAL 7033, RAL 7044, RAL 7045,
RAL 8014, RAL 9011.

 - * Setup costs for the first custom colour: € 225,00
 - Setup costs for every next custom colour: € 75,00

2. De Vorm offers a variety of tabletop options:

- 28 mm MDF core + HPL, veneer, Fenix or Desktop top layer
- 27 mm Plywood core + HPL, veneer, Fenix or Desktop top layer
- Diverse edge finishes

Please, contact De Vorm for more information about available options.

3. Tabletop can be equipped with cable cubbies. Find our standard cable cubby options on page 43.

Lite Round Modular Table System



Prices as mentioned on the right are indications based on the smallest length and depth, a 28mm MDF core with an HPL Duropal U11026 finish, straight edges, and a matching edgeband.

Prices depend on the diameter, finish of the tabletop and the ordered quantity.

Please, contact De Vorm for the exact quotation.

Ø Tabletop	Lite Round 74	Lite Round 95	Lite Round 110
120	€ 1.791,00	€ 1.825,00	€ 1.854,00
130	€ 1.810,00	€ 1.844,00	€ 1.873,00
140	€ 2.033,00	€ 2.067,00	€ 2.096,00
150	€ 2.054,00	€ 2.088,00	€ 2.117,00
159	€ 2.075,00	€ 2.109,00	€ 2.138,00

Leg options



Anodised legs

Steel legs

Solid Oak legs

Specifications

Standard frame & legs
Height

Anodised aluminium (VOM1 Natural)
74 / 95 / 110 cm

Bespoke options

- De Vorm offers the possibility to customise the legs of the Lite Table:
 - Solid oak legs for Lite Round 74 **no surcharge**
 - Powder-coated steel legs, Black (RAL 9011) **no surcharge**
 - Anodised or steel legs in custom RAL colour* **€ 40,00**
 - Anodised or steel legs in Fine texture* **€ 50,00**

Fine texture is only available in the following RAL colours:
RAL 1012, RAL 3005, RAL 5008, RAL 5020, RAL 6007,
RAL 6020, RAL 7015, RAL 7033, RAL 7044, RAL 7045,
RAL 8014, RAL 9011.

 - * Setup costs for the first custom colour: **€ 225,00**
 - Setup costs for every next custom colour: **€ 75,00**







2. De Vorm offers a variety of tabletop options:

- 28 mm MDF core + HPL, veneer, Fenix or Desktop top layer
- 27 mm Plywood core + HPL, veneer, Fenix or Desktop top layer
- Diverse edge finishes



Please, contact De Vorm for more information about available options.

3. Tabletop can be equipped with cable cubbies. Find our standard cable cubby options on page 43.

Table Add-ons

Cable Cubbies + Tray		Colours	Price
Bachmann Coni S 3x 230V RA 		Grey metallic	€ 236,00
		White	€ 250,00
		Black	€ 250,00
Bachmann Coni S USB 2x 230V RA + 2x USB-charger 		Grey metallic	€ 291,00
		White	€ 299,00
		Black	€ 299,00
Bachmann Pix 1x 230V RA 		White + Black	€ 35,00
Bachmann Power Frame M 4v 3x 230V RA + 2x USB-charger 		Aluminium	€ 197,00
		Black	€ 197,00
		White	€ 206,00
Bachmann Power Frame M Cover 4v 3x 230V RA + 2x USB-charger 		Aluminium	€ 313,00
		Black	€ 341,00
		White	€ 283,00
Cable Organiser Power strip tray + set of cable binders 		Grey metallic	€ 50,00
Set of cable binders			€ 15,00
1. All cable cubbies are delivered with 0,2m Wieland GST18i3 connector. 2. If you would like to equip a table with a custom cable cubby unit, the tabletop can be produced with one or more cut-outs.		Surcharge per cut-out	€ 25,00

Column Series

		Frame Black	Frame Custom colour ¹	Frame Fine texture ²
Column Table Round 60		€ 625,00	€ 683,00	€ 695,00
Column Table Round 90		€ 750,00	€ 808,00	€ 820,00
Column Table Round 120		€ 1.083,00	€ 1.142,00	€ 1.153,00

Setup costs custom colour treatment (frame)
 Setup costs for the first colour are € 225,00
 Setup costs for every next colour are € 75,00

Measurements Column Table Round 60

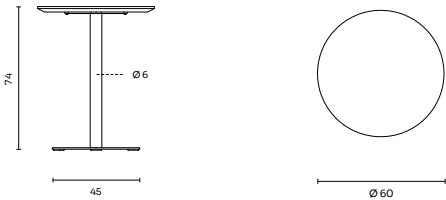

Specifications

Designed by	De Vorm
Standard tabletop	28 mm MDF core + HPL U12290 SD top layer, edges tapered and clear lacquered
Frame	Power-coated steel
Standard frame colour	Black (RAL 9011) with 70% gloss degree

Bespoke options

¹ Specified costs are based on custom RAL colours as shown in gloss degree 70%. Please, contact De Vorm for availability of the preferred colour. If the RAL colour is not in stock, there may be a price consequence.

² Specified costs are based on and only available in the following RAL fine texture colours: RAL 1012, RAL 3005, RAL 5008, RAL 5020, RAL 6007, RAL 6020, RAL 7015, RAL 7033, RAL 7044, RAL 7045, RAL 8014, RAL 9011.

The tabletop is also available in other HPL, Forbo Desktop, Fenix, or veneer finishes. Contact De Vorm for more information about available options.

Additional information

The MDF core is CARB II certified.

Measurements Column Table Round 90

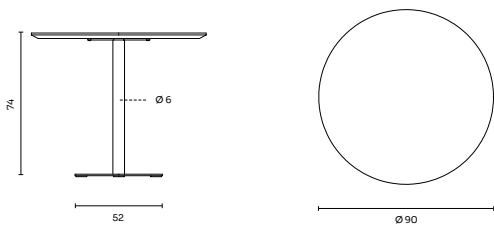

Measurements Column Table Round 120

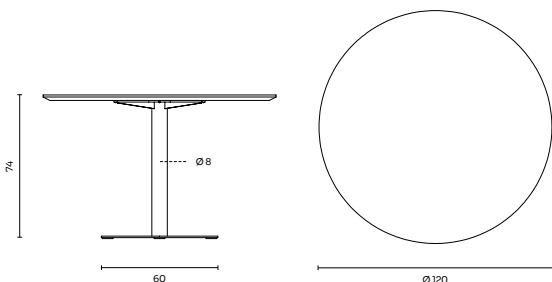

MG Series

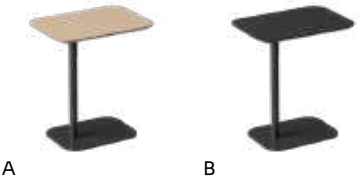
		Frame Black	Frame Custom colour ¹	Frame Fine texture ²
MG 1 Side Table	 <p>A B</p>	€ 383,00	€ 425,00	€ 437,00

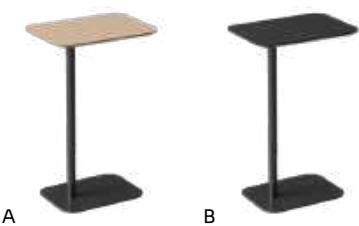
MG 2 Side Table	 <p>A B</p>	€ 392,00	€ 433,00	€ 445,00
-----------------	--	----------	----------	----------

Setup costs custom colour treatment (frame)
 Setup costs for the first colour are € 225,00
 Setup costs for every next colour are € 75,00

Measurements MG 1 Side Table

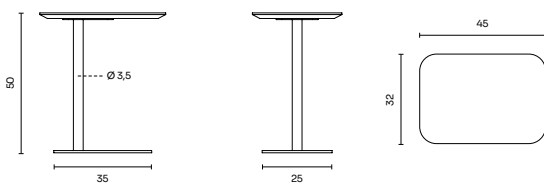

Measurements MG 2 Side Table

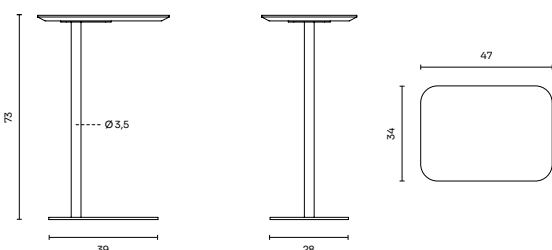

Specifications

Designed by
 Standard tabletops

De Vorm

- A. 19 mm MDF core + Oak veneer top layer, edges tapered and clear lacquered
- B. 19 mm Black MDF core + FenixNTM 0720 top layer, edges tapered and clear lacquered

Frame
 Standard frame colour

Power-coated steel
 Black (RAL 9011) with 70% gloss degree

Bespoke options

¹ Specified costs are based on custom RAL colours as shown in gloss degree 70%. Please, contact De Vorm for availability of the preferred colour. If the RAL colour is not in stock, there may be a price consequence.

² Specified costs are based on and only available in the following RAL fine texture colours: RAL 1012, RAL 3005, RAL 5008, RAL 5020, RAL 6007, RAL 6020, RAL 7015, RAL 7033, RAL 7044, RAL 7045, RAL 8014, RAL 9011.

The tabletop is also available in other HPL, Forbo, Fenix or veneer finishes. Please, contact De Vorm for more information about available options.

Additional information

The MDF core is CARB II certified.

MG Series

	Frame Black	Frame Custom colour ¹	Frame Fine texture ²
MG 3 Table	€ 492,00	€ 533,00	€ 545,00

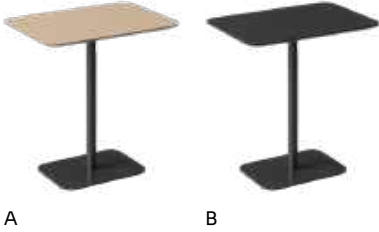

MG 3 Table variants A and B are shown. Variant A has a light-colored top and a black frame. Variant B has a black top and a black frame. Both have a single central leg and a square base.

MG 4 Table	A € 1.327,00	€ 1.410,00	€ 1.433,00
	B € 1.327,00	€ 1.410,00	€ 1.433,00

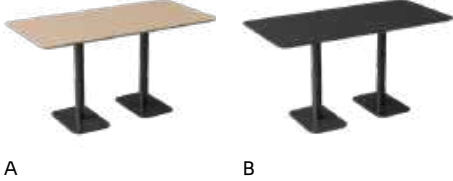

MG 4 Table variants A and B are shown. Variant A has a light-colored top and a black frame. Variant B has a black top and a black frame. Both have two legs and a rectangular base.

Setup costs custom colour treatment (frame)
 Setup costs for the first colour are € 225,00
 Setup costs for every next colour are € 75,00

Measurements MG 3 Table

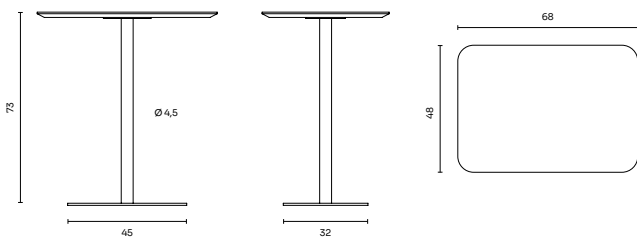

Measurements MG 4 Table

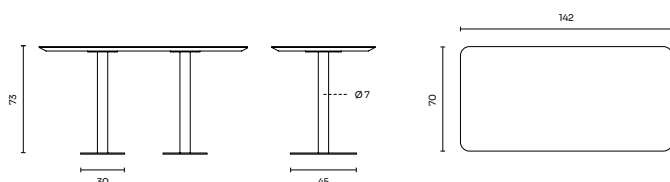

Specifications

Designed by
 Standard tabletops

De Vorm

- A. MDF core + Oak veneer top layer, edges tapered and clear lacquered
- B. Black MDF core + Fenix^{NTM} 0720 top layer, edges tapered and clear lacquered

Frame
 Standard frame colour

Power-coated steel
 Black (RAL 9011) with 70% gloss degree

Bespoke options

¹ Specified costs are based on custom RAL colours as shown in gloss degree 70%. Please, contact De Vorm for availability of the preferred colour. If the RAL colour is not in stock, there may be a price consequence.

² Specified costs are based on and only available in the following RAL fine texture colours: RAL 1012, RAL 3005, RAL 5008, RAL 5020, RAL 6007, RAL 6020, RAL 7015, RAL 7033, RAL 7044, RAL 7045, RAL 8014, RAL 9011.

The tabletop is also available in other HPL, Forbo, Fenix or veneer finishes. Please, contact De Vorm for more information about available options.

Additional information

The MDF core is CARB II certified.

Tabletop thickness for MG 3 is 19 mm

Tabletop thickness for MG 4 is 25 mm (Black MDF) or 28 mm (Clear MDF)

Pico

	Frame Black	Frame Custom colour ¹	Frame Fine texture ²
Pico Coffee Table	A € 458,00	€ 508,00	€ 583,00
Table	B € 425,00	€ 475,00	€ 550,00

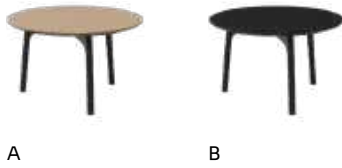

Setup costs custom colour treatment (frame)
 Setup costs for the first colour are € 225,00
 Setup costs for every next colour are € 75,00

Measurements Pico Coffee Table

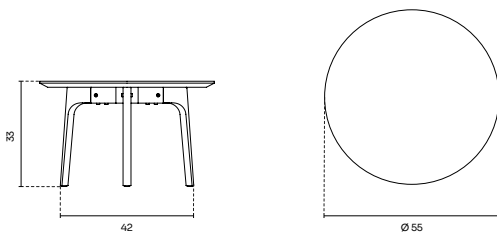

Specifications

Designed by	De Vorm
Standard tabletops	A. 19 mm MDF core + Oak veneer top layer, edges tapered and clear lacquered B. 19 mm Black MDF core + FenixNTM 0720 top layer, edges tapered and clear lacquered
Frame	Power-coated steel
Standard frame colour	Black (RAL 9011) with 70% gloss degree

Bespoke options

¹ Specified costs are based on custom RAL colours as shown in gloss degree 70%. Please, contact De Vorm for availability of the preferred colour. If the RAL colour is not in stock, there may be a price consequence.

² Specified costs are based on and only available in the following RAL fine texture colours: RAL 1012, RAL 3005, RAL 5008, RAL 5020, RAL 6007, RAL 6020, RAL 7015, RAL 7033, RAL 7044, RAL 7045, RAL 8014, RAL 9011.

The tabletop is also available in other HPL, Forbo, Fenix or veneer finishes. Please, contact De Vorm for more information about available options.

Additional information

The MDF core is CARB II certified.

Musette Series

		Standard ¹	Custom ²	Fine texture ³
Musette Coffee Table		€ 775,00	€ 815,00	€ 822,00

Musette Side Table		€ 742,00	€ 782,00	€ 788,00
--------------------	---	----------	----------	----------

Setup costs custom colour treatment (frame)
 Setup costs for the first colour are € 225,00
 Setup costs for every next colour are € 75,00

Measurements Musette Coffee Table

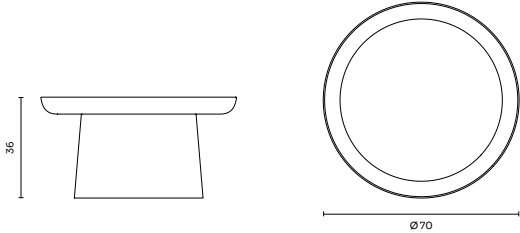

Measurements Musette Side Table

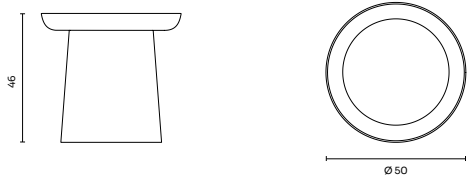

Specifications

Designed by **Ionna Vautrin**
 Tray & base **Powder-coated aluminium**

Bespoke options

- ¹ Specified costs are based on the following RAL fine texture colours: Olive (RAL 7033), Silk Grey (RAL 7044), Light Grey (RAL 7045)
- ² Specified costs are based on custom RAL colours as shown in 70% gloss degree. Please, contact De Vorm for availability of the preferred colour. If the RAL colour is not in stock, there may be a price consequence.
- ³ Specified costs are based on and only available in the following RAL fine texture colours: RAL 1012, RAL 3005, RAL 5008, RAL 5020, RAL 6007, RAL 6020, RAL 7015, RAL 8014, RAL 9011.

Hale Table

		Frame Black	Frame Custom colour ¹	Frame Fine texture ²
Hale Table White		€ 1.042,00	€ 1.100,00	€ 1.170,00
Hale Table Black		€ 1.042,00	€ 1.100,00	€ 1.170,00

Setup costs custom colour treatment (frame)
Setup costs for the first colour are € 225,00
Setup costs for every next colour are € 75,00

Measurements

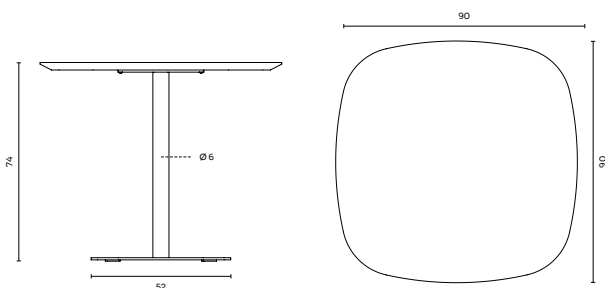

Specifications

Designed by
Standard tabletop

De Vorm

White: 28 mm MDF core + FenixNTM 0029 Bianco Malé top layer, edges tapered and white lacquered. Finished with a clear matt lacquer

Black: 25 mm Black MDF core + FenixNTM 0720 Nero Ingo top layer, edges tapered and clear matt lacquered

Frame
Standard frame colour

Powder-coated steel
Black (RAL 9011) with 70% gloss degree

Bespoke options

¹ Specified costs are based on custom RAL colours as shown in gloss degree 70%. Please, contact De Vorm for availability of the preferred colour. If the RAL colour is not in stock, there may be a price consequence.

² Specified costs are based on and only available in the following RAL fine texture colours: RAL 1012, RAL 3005, RAL 5008, RAL 5020, RAL 6007, RAL 6020, RAL 7015, RAL 7033, RAL 7044, RAL 7045, RAL 8014, RAL 9011.

Additional information

The MDF core is CARB II certified

Acoustics

Mute Series

Mute Fit Acoustic Panel



Panel	Qty	Ex. VAT
Dark Grey, Light Grey	1	€ 367,00
	10	€ 358,00
	25	€ 350,00
	50	€ 342,00
	Colour blends	1
Colour blends	10	€ 408,00
	25	€ 400,00
	50	€ 392,00

Quantity discount applies when ordering panels of the same type and colour.

Measurements

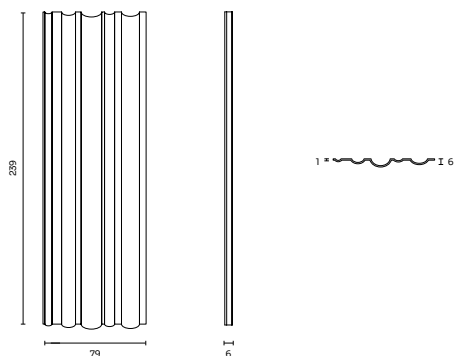

Specifications

Designed by
Material
PET Felt blends

De Vorm
PET Felt
Marine, Turquoise, Olive, Dark Green,
Green, Yellow, Pink, Dark Grey, Light Grey,
Brown, Beige

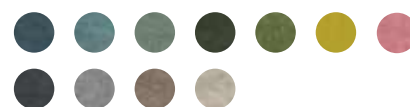

Additional information

PET Felt is made of recycled material. Slight colour deviations may appear between different products.

The panels can be treated with a fire retardant product.
See page 79 for the surcharges.

Mute Series

Mute Fraction Acoustic Panel



Panel	Qty	Ex. VAT
Dark Grey, Light Grey	1	€ 367,00
	10	€ 358,00
	25	€ 350,00
	50	€ 342,00
	Colour blends	1
	10	€ 408,00
	25	€ 400,00
	50	€ 392,00

Quantity discount applies when ordering panels of the same type and colour.

Measurements

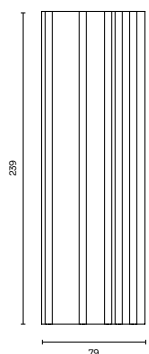

1" 4,3

Specifications

Designed by
Material
PET Felt blends

De Vorm
PET Felt
Marine, Turquoise, Olive, Dark Green,
Green, Yellow, Pink, Dark Grey, Light Grey,
Brown, Beige

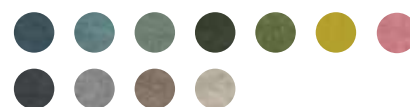

Additional information

PET Felt is made of recycled material. Slight colour deviations may appear between different products.

The panels can be treated with a fire retardant product.
See page 79 for the surcharges.

Mute Series

Mute Flat Acoustic Panel



Panel	Qty	Ex. VAT
Dark Grey, Light Grey	1	€ 367,00
	10	€ 358,00
	25	€ 350,00
	50	€ 342,00
Colour blends	1	€ 417,00
	10	€ 408,00
	25	€ 400,00
	50	€ 392,00

Quantity discount applies when ordering panels of the same type and colour.

Measurements

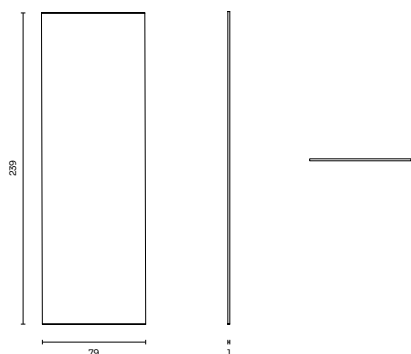

Specifications

Designed by
Material
PET Felt blends

De Vorm
PET Felt
Marine, Turquoise, Olive, Dark Green,
Green, Yellow, Pink, Dark Grey, Light Grey,
Brown, Beige

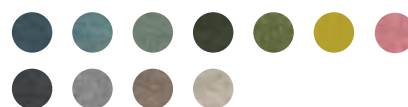

Additional information

PET Felt is made of recycled material. Slight colour deviations may appear between different products.

The panels can be treated with a fire retardant product.
See page 79 for the surcharges.

Mute Series

Mute Flow Acoustic Panel



Panel	Qty	Ex. VAT
Dark Grey, Light Grey	1	€ 367,00
	10	€ 358,00
	25	€ 350,00
	50	€ 342,00
Colour blends	1	€ 417,00
	10	€ 408,00
	25	€ 400,00
	50	€ 392,00

Quantity discount applies when ordering panels of the same type and colour.

Measurements

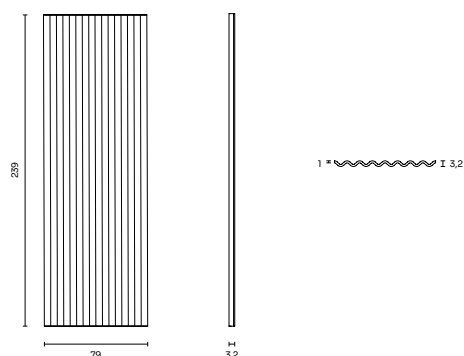

Specifications

Designed by
Material
PET Felt blends

De Vorm
PET Felt
Marine, Turquoise, Olive, Dark Green,
Green, Yellow, Pink, Dark Grey, Light Grey,
Brown, Beige



Additional information

PET Felt is made of recycled material. Slight colour deviations may appear between different products.

The panels can be treated with a fire retardant product.
See page 79 for the surcharges.

Mute Series

Mute Peak Acoustic Panel



Panel	Qty	Ex. VAT
Dark Grey, Light Grey	1	€ 367,00
	10	€ 358,00
	25	€ 350,00
	50	€ 342,00
	Colour blends	1
Colour blends	10	€ 408,00
	25	€ 400,00
	50	€ 392,00

Quantity discount applies when ordering panels of the same type and colour.

Measurements

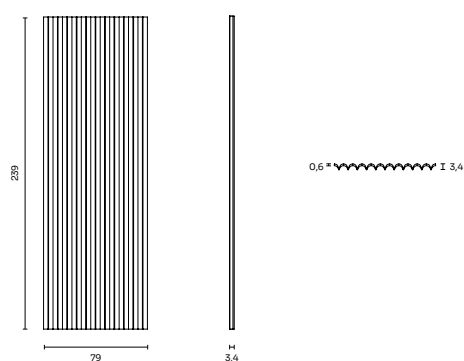

Specifications

Designed by
Material
PET Felt blends

De Vorm
PET Felt
Marine, Turquoise, Olive, Dark Green,
Green, Yellow, Pink, Dark Grey, Light Grey,
Brown, Beige



Additional information

PET Felt is made of recycled material. Slight colour deviations may appear between different products.

The panels can be treated with a fire retardant product.
See page 79 for the surcharges.

Mute Series

Mute Flow Floating	Panel	Qty	Tubes Black	Tubes Custom colour ¹	Tubes Fine texture ²
	Dark Grey, Light Grey	1	€ 708,00	€ 750,00	€ 762,00
	Colour blends	1	€ 792,00	€ 833,00	€ 845,00

Setup costs custom colour treatment (frame)

Setup costs for the first colour are € 225,00

Setup costs for every next colour are € 75,00

Measurements

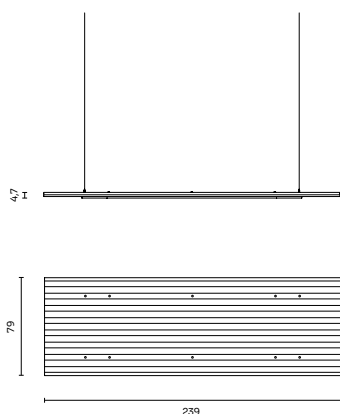

Specifications

Designed by

Tubes

Standard tube colour

Panel

PET Felt blends

De Vorm

Powder-coated steelt

Black (RAL 9011) with 70% gloss degree

PET Felt

Marine, Turquoise, Olive, Dark Green, Green, Yellow, Pink, Dark Grey, Light Grey, Brown, Beige

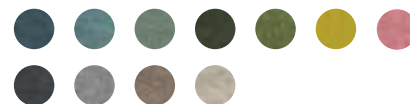

Bespoke options

¹ Specified costs are based on custom RAL colours as shown in gloss degree 70%. Please, contact De Vorm for availability of the preferred colour. If the RAL colour is not in stock, there may be a price consequence.

² Specified costs are based on and only available in the following RAL fine texture colours: RAL 1012, RAL 3005, RAL 5008, RAL 5020, RAL 6007, RAL 6020, RAL 7015, RAL 7033, RAL 7044, RAL 7045, RAL 8014, RAL 9011.

These colours match perfectly with our PET Felt blends.

See page 81 for ton-sur-ton colour combinations.

Additional information

PET Felt is made of recycled material. Slight colour deviations may appear between different products.

The panels can be treated with a fire retardant product.

See page 79 for the surcharges.

Mute Series

Mute Flow Floating Lamp	Panel	Qty	Tubes Black	Tubes Custom colour ¹	Tubes Fine texture ²
	Dark Grey, Light Grey	1	€ 958,00	€ 1.000,00	€ 1.012,00
	Colour blends	1	€ 1.042,00	€ 1.083,00	€ 1.095,00

Setup costs custom colour treatment (frame)

Setup costs for the first colour are € 225,00

Setup costs for every next colour are € 75,00

Measurements

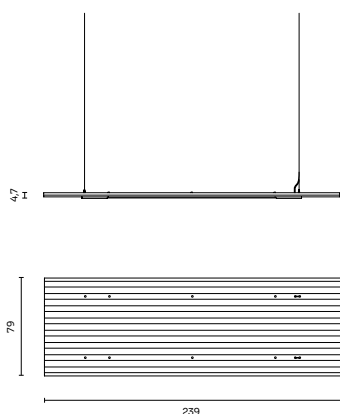

Specifications

Designed by

De Vorm

Tubes

Powder-coated steel

Standard tube colour

Black (RAL 9011) with 70% gloss degree

Lights

2 x Philips MAS LEDtube 1500mm 18.2W 840
3100 Lm T8 (non-dimmable)

Panel

PET Felt

PET Felt blends

Marine, Turquoise, Olive, Dark Green,
Green, Yellow, Pink, Dark Grey, Light Grey,
Brown, Beige

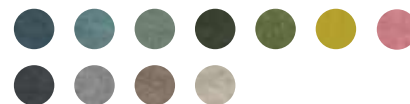

Bespoke options

¹ Specified costs are based on custom RAL colours as shown in gloss degree 70%. Please, contact De Vorm for availability of the preferred colour. If the RAL colour is not in stock, there may be a price consequence.

² Specified costs are based on and only available in the following RAL fine texture colours: RAL 1012, RAL 3005, RAL 5008, RAL 5020, RAL 6007, RAL 6020, RAL 7015, RAL 7033, RAL 7044, RAL 7045, RAL 8014, RAL 9011.

These colours match perfectly with our PET Felt blends.

See page 81 for ton-sur-ton colour combinations.

Additional information

PET Felt is made of recycled material. Slight colour deviations may appear between different products.

The panels can be treated with a fire retardant product.

See page 79 for the surcharges.

Mute Series

Mute Flow Room Divider	Panel	Qty	Stand Black	Stand Custom colour ¹	Stand Fine texture ²
	Dark Grey, Light Grey	1	€ 742,00	€ 825,00	€ 848,00
	Colour blends	1	€ 833,00	€ 917,00	€ 940,00

Setup costs custom colour treatment (frame)

Setup costs for the first colour are € 225,00

Setup costs for every next colour are € 75,00

Measurements

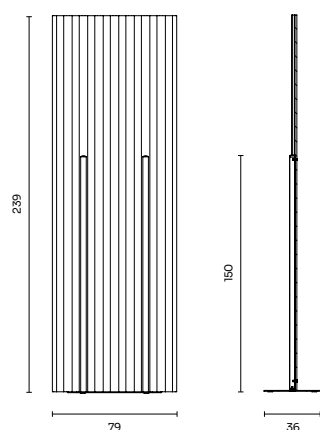

Specifications

Designed by

Tubes

Standard tube colour

Panel

PET Felt blends

De Vorm

Powder-coated steelt

Black (RAL 9011) with 70% gloss degree

PET Felt

Marine, Turquoise, Olive, Dark Green, Green, Yellow, Pink, Dark Grey, Light Grey, Brown, Beige

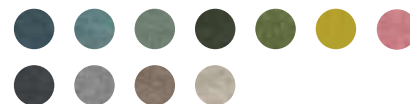

Bespoke options

¹ Specified costs are based on custom RAL colours as shown

in gloss degree 70%. Please, contact De Vorm for availability of the preferred colour. If the RAL colour is not in stock, there may be a price consequence.

² Specified costs are based on and only available in the following RAL fine texture colours: RAL 1012, RAL 3005, RAL 5008, RAL 5020, RAL 6007, RAL 6020, RAL 7015, RAL 7033, RAL 7044, RAL 7045, RAL 8014, RAL 9011.

These colours match perfectly with our PET Felt blends.

See page 81 for ton-sur-ton colour combinations.

Additional information

PET Felt is made of recycled material. Slight colour deviations may appear between different products.

The panels can be treated with a fire retardant product.

See page 79 for the surcharges.

AK Series

AK 1 Workplace Divider



Colour	Qty	Ex. VAT
Dark Grey, Light Grey	1	€ 333,00
Colour blends	1	€ 350,00

Measurements

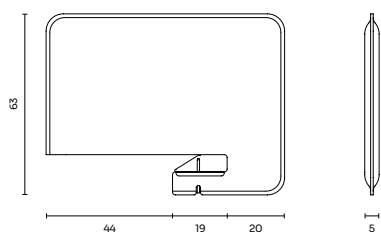

Specifications

Designed by

Material

PET Felt blends

De Vorm

PET Felt

Marine, Turquoise, Olive, Dark Green, Green, Yellow, Pink, Dark Grey, Light Grey, Brown, Beige

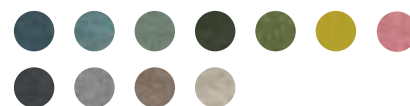

Additional information

- PET Felt is made of recycled material. Slight colour deviations may appear between different products.
- Suitable for tabletops from 20 mm up to 40 mm

AK Series

AK 2 Workplace Divider Lamps	Shell	Qty	Fixture / Feet Black	Fixture / Feet Custom colour ¹	Fixture / Feet Fine texture ²
AK 2 Workplace Divider Lamp Hanging	Dark Grey, Light Grey	1	€ 833,00	€ 850,00	€ 862,00
	Colour blends	1	€ 875,00	€ 892,00	€ 903,00



AK 2 Workplace Divider Lamp Standing	Dark Grey, Light Grey	1	€ 858,00	€ 892,00	€ 913,00
	Colour blends	1	€ 958,00	€ 992,00	€ 1.013,00



Setup costs for the first custom colour (fixture/feet): € 125,00
 Setup costs for every next custom colour: € 75,00

Measurements AK 2 Hanging

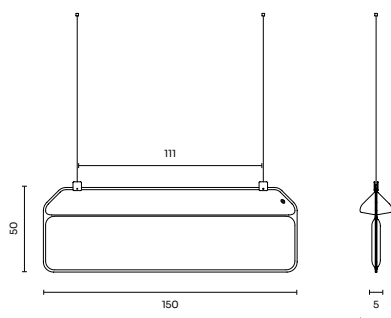

Measurements AK 2 Standing

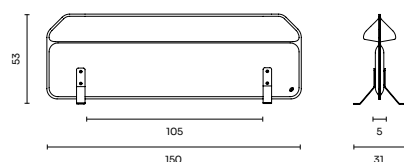

Specifications

Designed by
 Fixture / feet
 Standard fixture / feet colour
 Lights

Shell
 PET Felt blends

Ivan Kasner & Uli Budde
 Powder-coated steelt
 Black (RAL 9011) with 70% gloss degree
 2x Philips CorePro LEDtube 1200mm
 14.5W840 (non-dimmable)
 PET Felt
 Marine, Turquoise, Olive, Dark Green,
 Green, Yellow, Pink, Dark Grey, Light Grey,
 Brown, Beige

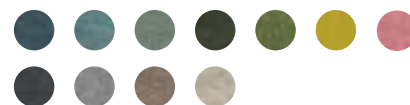

Bespoke options

¹ The colour of the fixture and feet can be customised. Specified costs are based on RAL colours as shown in gloss degree 70%. Please, contact De Vorm for availability of the preferred colour. If the RAL colour is not in stock, there may be a price consequence.

² Specified costs are based on and only available in the following RAL fine texture colours: RAL 1012, RAL 3005, RAL 5008, RAL 5020, RAL 6007, RAL 6020, RAL 7015, RAL 7033, RAL 7044, RAL 7045, RAL 8014, RAL 9011.

*These colours match perfectly with our PET Felt blends.
 See page 81 for ton-sur-ton colour combinations.*

The length of steel cables and cord can be customised upon request. Please, contact De Vorm for more information.

Additional information

- PET Felt is made of recycled material. Slight colour deviations may appear between different products.
- AK 2 Hanging comes with 3-meter steel cables and a transparent cord.
- AK 2 Standing comes with a 3-meter transparent cord and plug.

AK Series

AK 3 Workplace Dividers	Panel	Qty	Fixture / Feet Black	Fixture / Feet Custom colour ¹	Fixture / Feet Fine texture ²
AK 3 Workplace Divider Hanging (horizontal)	Dark Grey, Light Grey	1	€ 575,00	€ 592,00	€ 603,00
	Colour blends	1	€ 608,00	€ 625,00	€ 637,00
AK 3 Workplace Divider Standing (horizontal)	Dark Grey, Light Grey	1	€ 708,00	€ 742,00	€ 763,00
	Colour blends	1	€ 742,00	€ 775,00	€ 797,00
AK 3 Desk Clamp	Dark Grey, Light Grey	1	€ 542,00	€ 558,00	€ 570,00
	Colour blends	1	€ 575,00	€ 592,00	€ 603,00

Setup costs for the first custom colour (fixture/feet): € 125,00
 Setup costs for every next custom colour: € 75,00

Measurements AK 3 Workplace Divider Hanging

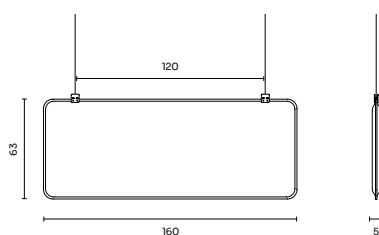

Measurements AK 3 Workplace Divider Standing

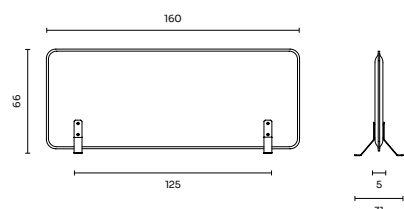

Measurements AK 3 Desk Clamp

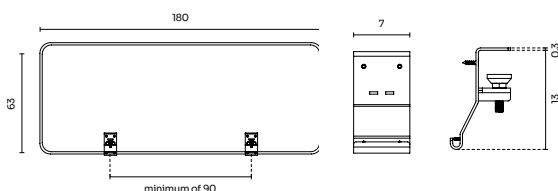

Specifications

Designed by
 Fixture / feet / clamp
 Standard fixture / feet colour
 Panel
 PET Felt blends

De Vorm
 Powder-coated steelt
 Black (RAL 9011) with 70% gloss degree
 PET Felt
 Marine, Turquoise, Olive, Dark Green,
 Green, Yellow, Pink, Dark Grey, Light Grey,
 Brown, Beige

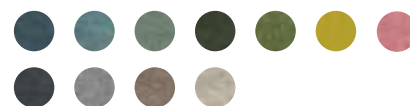

Bespoke options

¹ Specified costs are based on custom RAL colours as shown in gloss degree 70%. Please, contact De Vorm for availability of the preferred colour. If the RAL colour is not in stock, there may be a price consequence.

² Specified costs are based on and only available in the following RAL fine texture colours: RAL 1012, RAL 3005, RAL 5008, RAL 5020, RAL 6007, RAL 6020, RAL 7015, RAL 7033, RAL 7044, RAL 7045, RAL 8014, RAL 9011. *These colours match perfectly with our PET Felt blends.*
 See page 76 for ton-sur-ton colour combinations.

Additional information

PET Felt is made of recycled material. Slight colour deviations may appear between different products.

AK Series

AK 4 Workplace Dividers	Panel	Qty	Fixture / Feet Black	Fixture / Feet Custom colour ¹	Fixture / Feet Fine texture ²
AK 4 Workplace Divider Hanging (horizontal)	Dark Grey, Light Grey	1	€ 608,00	€ 642,00	€ 663,00
	Colour blends	1	€ 642,00	€ 658,00	€ 670,00



AK 4 Workplace Divider Standing (horizontal)	Dark Grey, Light Grey	1	€ 742,00	€ 775,00	€ 797,00
	Colour blends	1	€ 775,00	€ 808,00	€ 830,00



AK 4 Desk Clamp	Dark Grey, Light Grey	1	€ 575,00	€ 592,00	€ 603,00
	Colour blends	1	€ 608,00	€ 625,00	€ 637,00



Setup costs for the first custom colour (fixture/feet): € 125,00
Setup costs for every next custom colour: € 75,00

Measurements AK 4 Workplace Divider Hanging

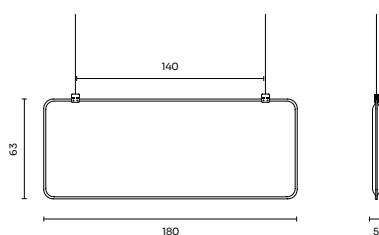

Measurements AK 4 Workplace Divider Standing

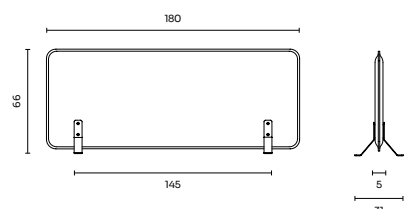

Measurements AK 4 Desk Clamp

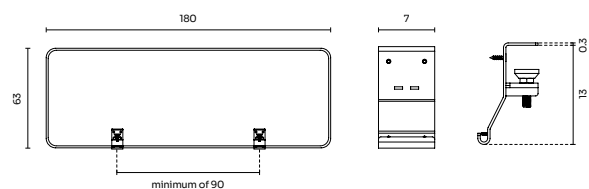

Specifications

Designed by
Fixture / feet / clamp
Standard fixture / feet colour
Panel
PET Felt blends

De Vorm
Powder-coated steelt
Black (RAL 9011) with 70% gloss degree
PET Felt
Marine, Turquoise, Olive, Dark Green,
Green, Yellow, Pink, Dark Grey, Light Grey,
Brown, Beige

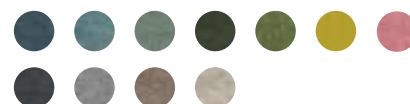

Bespoke options

¹ Specified costs are based on custom RAL colours as shown in gloss degree 70%. Please, contact De Vorm for availability of the preferred colour. If the RAL colour is not in stock, there may be a price consequence.

² Specified costs are based on and only available in the following RAL fine texture colours: RAL 1012, RAL 3005, RAL 5008, RAL 5020, RAL 6007, RAL 6020, RAL 7015, RAL 7033, RAL 7044, RAL 7045, RAL 8014, RAL 9011. These colours match perfectly with our PET Felt blends. See page 76 for ton-sur-ton colour combinations.

Additional information

PET Felt is made of recycled material. Slight colour deviations may appear between different products.

AK Series

AK 3 Room Dividers	Panel	Qty	Fixture / Feet Black	Fixture / Feet Custom colour ¹	Fixture / Feet Fine texture ²
AK 3 Room Divider Hanging (vertical)	Dark Grey, Light Grey	1	€ 575,00	€ 592,00	€ 603,00
	Colour blends	1	€ 608,00	€ 625,00	€ 637,00



AK 3 Room Divider Standing (vertical)	Dark Grey, Light Grey	1	€ 708,00	€ 742,00	€ 763,00
	Colour blends	1	€ 742,00	€ 775,00	€ 797,00



Setup costs for the first custom colour (fixture/feet): € 125,00
Setup costs for every next custom colour: € 75,00

Measurements AK 3 Room Divider Hanging

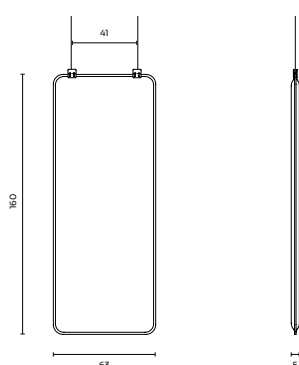

Measurements AK 3 Room Divider Standing

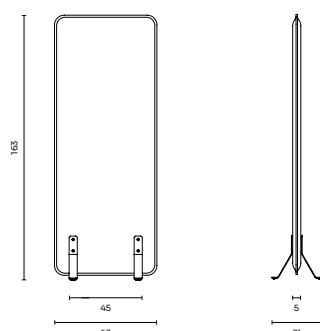

Specifications

Designed by
Fixture / feet
Standard fixture / feet colour
Panel
PET Felt blends

De Vorm
Powder-coated steelt
Black (RAL 9011) with 70% gloss degree
PET Felt
Marine, Turquoise, Olive, Dark Green,
Green, Yellow, Pink, Dark Grey, Light Grey,
Brown, Beige



Bespoke options

¹ Specified costs are based on custom RAL colours as shown in gloss degree 70%. Please, contact De Vorm for availability of the preferred colour. If the RAL colour is not in stock, there may be a price consequence.

² Specified costs are based on and only available in the following RAL fine texture colours: RAL 1012, RAL 3005, RAL 5008, RAL 5020, RAL 6007, RAL 6020, RAL 7015, RAL 7033, RAL 7044, RAL 7045, RAL 8014, RAL 9011. *These colours match perfectly with our PET Felt blends. See page 81 for ton-sur-ton colour combinations.*

Additional information

PET Felt is made of recycled material. Slight colour deviations may appear between different products.

AK Series

AK 4 Room Dividers	Panel	Qty	Fixture / Feet Black	Fixture / Feet Custom colour ¹	Fixture / Feet Fine texture ²
AK 4 Room Divider Hanging (vertical)	Dark Grey, Light Grey	1	€ 608,00	€ 642,00	€ 663,00
	Colour blends	1	€ 642,00	€ 658,00	€ 670,00



AK 4 Room Divider Standing (vertical)	Dark Grey, Light Grey	1	€ 742,00	€ 775,00	€ 797,00
	Colour blends	1	€ 775,00	€ 808,00	€ 830,00



Setup costs for the first custom colour (fixture/feet): € 125,00
Setup costs for every next custom colour: € 75,00

Measurements AK 4 Room Divider Hanging

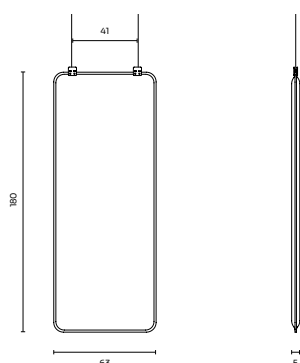

Measurements AK 4 Room Divider Standing

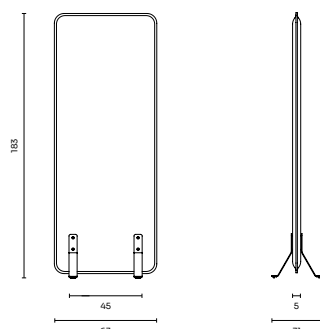

Specifications

Designed by
Fixture / feet
Standard fixture / feet colour
Panel
PET Felt blends

De Vorm
Powder-coated steelt
Black (RAL 9011) with 70% gloss degree
PET Felt
Marine, Turquoise, Olive, Dark Green,
Green, Yellow, Pink, Dark Grey, Light Grey,
Brown, Beige

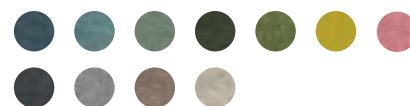

Bespoke options

¹ Specified costs are based on custom RAL colours as shown in gloss degree 70%. Please, contact De Vorm for availability of the preferred colour. If the RAL colour is not in stock, there may be a price consequence.

² Specified costs are based on and only available in the following RAL fine texture colours: RAL 1012, RAL 3005, RAL 5008, RAL 5020, RAL 6007, RAL 6020, RAL 7015, RAL 7033, RAL 7044, RAL 7045, RAL 8014, RAL 9011. *These colours match perfectly with our PET Felt blends. See page 81 for ton-sur-ton colour combinations.*

Additional information

PET Felt is made of recycled material. Slight colour deviations may appear between different products.

AK Series

		Qty	Hinge Black	Hinge Custom colour ¹	Hinge Fine texture ²
Hinge AK 3 + 4	Panels not included	1 set	€ 208,00	€ 242,00	€ 263,00



Setup costs for the first custom colour (fixture/feet): € 125,00

Setup costs for every next custom colour: € 75,00

Specifications

Designed by	De Vorm
Hinge	Powder-coated steelt
Standard hinge colour	Black (RAL 9011) with 70% gloss degree

Bespoke options

¹ Specified costs are based on custom RAL colours as shown in gloss degree 70%. Please, contact De Vorm for availability of the preferred colour. If the RAL colour is not in stock, there may be a price consequence.

² Specified costs are based on and only available in the following RAL fine texture colours: RAL 1012, RAL 3005, RAL 5008, RAL 5020, RAL 6007, RAL 6020, RAL 7015, RAL 7033, RAL 7044, RAL 7045, RAL 8014, RAL 9011. *These colours match perfectly with our PET Felt blends. See page 81 for ton-sur-ton colour combinations.*

Additional information

This set consists of two hinges and is suitable for connecting two AK 3 or AK 4 Room Dividers.

PET Felt is made of recycled material. Slight colour deviations may appear between different products.

Lighting

Pivot Series

	Shell	Qty	Ex. VAT
Pivot Adjustable Lamp	Dark Grey, Light Grey	1	€ 1.082,00
	Colour blends	1	€ 1.165,00



Pivot Adjustable Lamp Duo	Dark Grey, Light Grey	1	€ 1.498,00
	Colour blends	1	€ 1.748,00



Measurements Pivot Adjustable Lamp

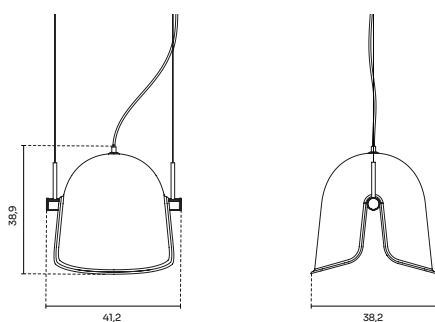

Measurements Pivot Adjustable Lamp Duo

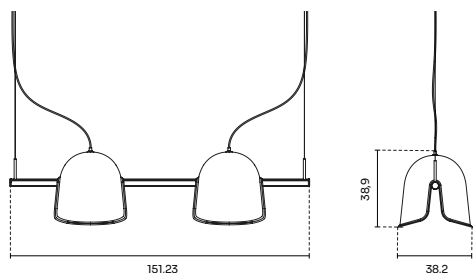

Specifications

Designed by	De Vorm
LED module	Ø 300mm, 25W
Light output	1800 Lm
Voltage	110V - 240V
Colour temperature	3000K / 4000K
Dimmable	Dali dimmable
Tube	Anodised aluminium (Black)
Shell	PET Felt
PET Felt blends	Marine, Turquoise, Olive, Dark Green, Green, Yellow, Pink, Dark Grey, Light Grey, Brown, Beige

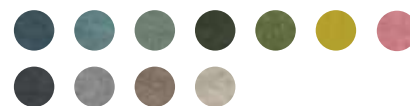

Additional information

- PET Felt is made of recycled material. Slight colour deviations may appear between different products.
- Steel cables and cord length can be customised upon request. Please, contact De Vorm for more information.

Fost Series

Fost Acoustic Lamp



Shell	Qty	Ex. VAT
Dark Grey, Light Grey	1	€ 992,00
Colour blends	1	€ 1.042,00

Measurements

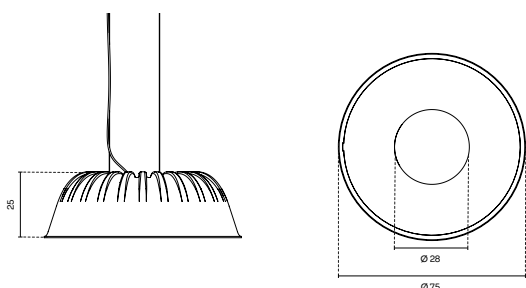

Specifications

Designed by	De Vorm
LED module	280mm, 10W
Light output	1100 Lm
Voltage	120 - 240V
Colour temperature	3000K / 4000K
Dimmable	DALI dimmable
Inner inlay	Textile (white)
Shell	PET Felt
PET Felt blends	Marine, Turquoise, Olive, Dark Green, Green, Yellow, Pink, Dark Grey, Light Grey, Brown, Beige

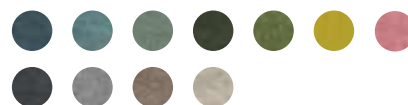

Additional information

- PET Felt is made of recycled material. Slight colour deviations may appear between different products.
- The length of steel cables and cord can be customised upon request. Please, contact De Vorm for more information.

Fost Series

Fost Large Acoustic Lamp



Shell	Qty	Ex. VAT
Dark Grey, Light Grey	1	€ 1.658,00
Colour blends	1	€ 1.742,00

Measurements

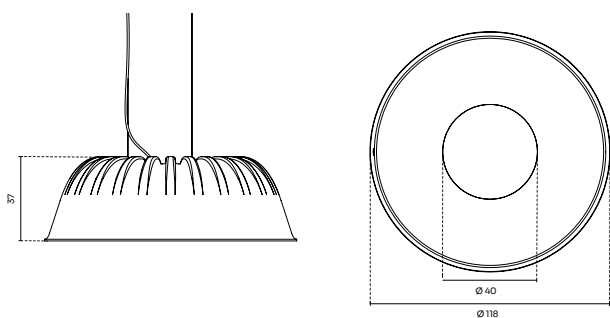

Specifications

Designed by	De Vorm
LED module	400mm, 12W
Light output	1400 Lm
Voltage	120 - 240V
Colour temperature	3000K / 4000K
Dimmable	DALI dimmable
Inner inlay	Textile (white)
Shell	PET Felt
PET Felt blends	Marine, Turquoise, Olive, Dark Green, Green, Yellow, Pink, Dark Grey, Light Grey, Brown, Beige

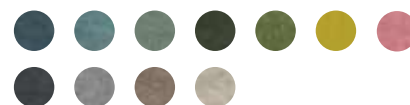

Additional information

- PET Felt is made of recycled material. Slight colour deviations may appear between different products.
- The length of steel cables and cord can be customised upon request. Please, contact De Vorm for more information.

Fost Series

Fost Bulb Acoustic Lamp



Shell	Qty	Ex. VAT
Dark Grey, Light Grey	1	€ 625,00
Colour blends	1	€ 667,00

Measurements

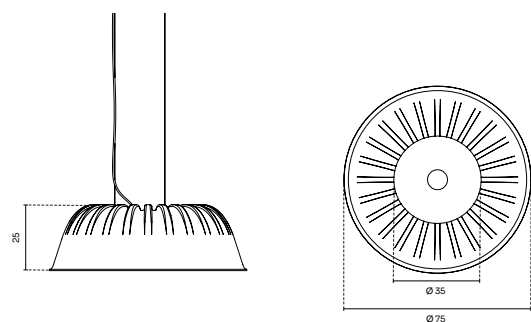

Specifications

Designed by
Fitting
Inner plate
Shell
PET Felt blends

De Vorm
E27
Steel, powder-coated (RAL 9010)
PET Felt
Marine, Turquoise, Olive, Dark Green, Green,
Yellow, Pink, Dark Grey, Light Grey,
Brown, Beige

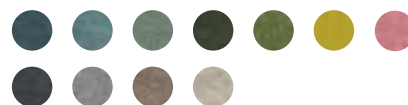

Additional information

- Light bulb is not included.
- PET Felt is made of recycled material. Slight colour deviations may appear between different products.
- The length of steel cables and cord can be customised upon request. Please, contact De Vorm for more information.

Fost Series

Fost Large Bulb Acoustic Lamp



Shell	Qty	Ex. VAT
Dark Grey, Light Grey	1	€ 1.158,00
Colour blends	1	€ 1.242,00

Measurements

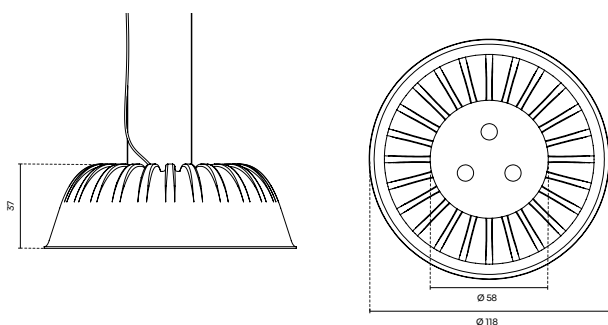

Specifications

Designed by
Fitting
Inner plate
Shell
PET Felt blends

De Vorm
E27 (3x)
Steel, powder-coated (RAL 9010)
PET Felt
Marine, Turquoise, Olive, Dark Green, Green,
Yellow, Pink, Dark Grey, Light Grey,
Brown, Beige

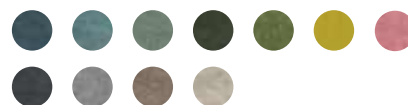

Additional information

- Light bulbs are not included.
- PET Felt is made of recycled material. Slight colour deviations may appear between different products.
- The length of steel cables and cord can be customised upon request. Please, contact De Vorm for more information.

Ratio Series

Lampshade Standard colours ¹Lampshade Custom colours ²

Ratio 19 Pendant Lamp

€ 208,00

€ 218,00



Ratio 29 Pendant Lamp

€ 225,00

€ 235,00



Ratio 39 Pendant Lamp

€ 242,00

€ 252,00



Setup costs custom colour treatment (frame)
 Setup costs for the first colour are € 225,00
 Setup costs for every next colour are € 75,00

Measurements Ratio 19 Pendant Lamp

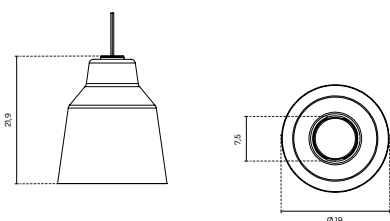

Specifications

Designed by	De Vorm
Lampshade	Wet-coated steel
Electrical cord	2-core wire, transparant, 3m
LED module*	LED GX53
Voltage	100 - 240V
Power	3W
Colour temperature	3000K / 4000K / 6500K
CRI	>80
Luminous flux	410 Lm
Dimmable	No

* Included LED module can be replaced with any GX53 type.

Measurements Ratio 29 Pendant Lamp

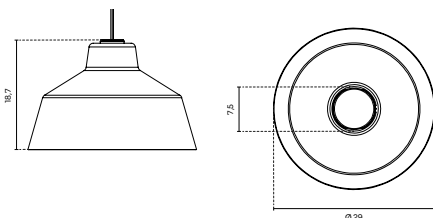

Bespoke options

¹Specified costs are based on the following RAL colours with matt finish: Burgundy (RAL 3005), Marine (RAL 5008), Olive (RAL 7033), Silk Grey (RAL 7044), Black (RAL 9011).

²Specified costs are based on custom RAL colours as shown with matt finish. Please, contact De Vorm for availability of the preferred colour. If the RAL colour is not in stock, there may be a price consequence. Please, contact De Vorm for more information.

Measurements Ratio 39 Pendant Lamp

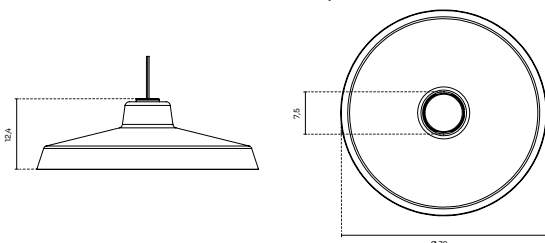

Split Series

Base + Cord Standard colours¹

Split Straight



€ 332,00

Split Straight Drum



€ 432,00

Split Straight Acorn



€ 432,00

Measurements Split Straight

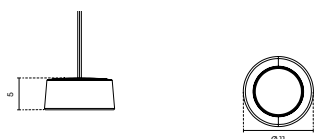

Measurements Split Straight Drum

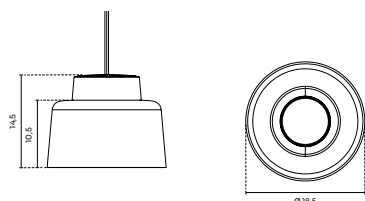

Measurements Split Straight Orbit

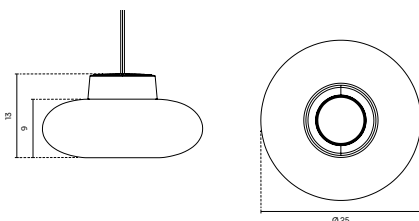

Specifications

Designed by	Jens Fager + De Vorm
Base	Zinc alloy, powder-coated
Lampshade	Opaque glass
Electrical cord	2-core wire, 3m
LED module*	LED GX53
Voltage	100 - 240V
Power	3W
Colour temperature	3000K / 4000K / 6500K
CRI	>80
Luminous flux	410 Lm
Dimmable	No

* Included LED module can be replaced with any GX53 type.

Bespoke options

¹ Specified costs are based on the following RAL colours in fine texture: Graphite Black (RAL 9011), Grey White (RAL 9002), Pine Green (RAL 6028), Olive (RAL 130.70.10), Soft Blue (RAL 240.80.10), Red Brown (RAL 8012).

Split Series

Base + Cord Standard colours¹

Split Straight Orbit

€ 465,00



Split Straight Dome

€ 498,00



Measurements Split Straight Dome

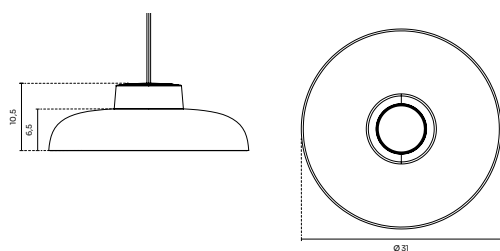

Measurements Split Straight Acorn

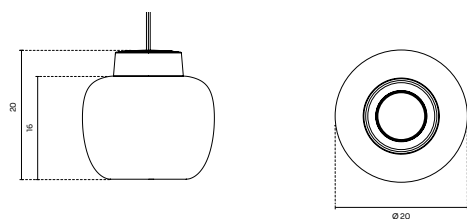

Specifications

Designed by	Jens Fager + De Vorm
Base	Zinc alloy, powder-coated
Lampshade	Opaque glass
Electrical cord	2-core wire, 3m
LED module*	LED GX53
Voltage	100 - 240V
Power	3W
Colour temperature	3000K / 4000K / 6500K
CRI	>80
Luminous flux	410 Lm
Dimmable	No

* Included LED module can be replaced with any GX53 type.

Bespoke options

¹ Specified costs are based on the following RAL colours in fine texture: Graphite Black (RAL 9011), Grey White (RAL 9002), Pine Green (RAL 6028), Olive (RAL 130.70.10), Soft Blue (RAL 240.80.10), Red Brown (RAL 8012).

Split Series

Base + Cord Custom colours¹

Split Round



€ 332,00

Split Round Drum



€ 432,00

Split Round Orbit



€ 465,00

Measurements Split Round

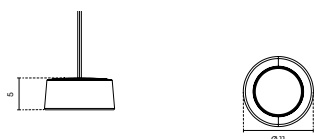

Measurements Split Round Drum

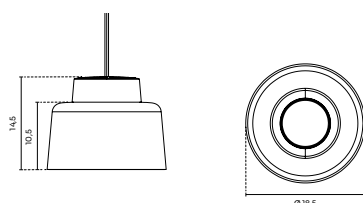

Measurements Split Round Orbit

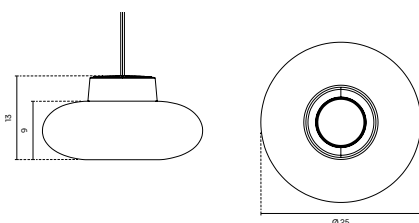

Specifications

Designed by	Jens Fager + De Vorm
Base	Zinc alloy, powder-coated
Lampshade	Opaque glass
Electrical cord	2-core wire, 3m
LED module*	LED GX53
Voltage	100 - 240V
Power	3W
Colour temperature	3000K / 4000K / 6500K
CRI	>80
Luminous flux	410 Lm
Dimmable	No

* Included LED module can be replaced with any GX53 type.

Bespoke options

¹ Specified costs are based on the following RAL colours in fine texture: Graphite Black (RAL 9011), Grey White (RAL 9002), Pine Green (RAL 6028), Olive (RAL 130.70.10), Soft Blue (RAL 240.80.10), Red Brown (RAL 8012).

Split Series

Base + Cord Custom colours¹

Split Round Dome

€ 498,00



Split Round Acorn

€ 432,00



Measurements Split Round Dome

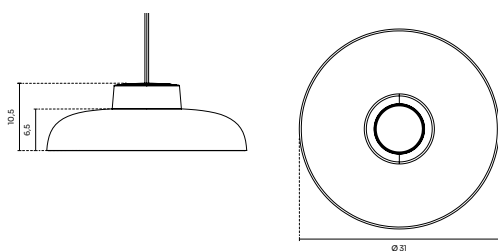

Measurements Split Round Acorn

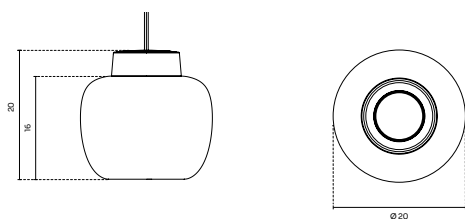

Specifications

Designed by	Jens Fager + De Vorm
Base	Zinc alloy, powder-coated
Lampshade	Opaque glass
Electrical cord	2-core wire, 3m
LED module*	LED GX53
Voltage	100 - 240V
Power	3W
Colour temperature	3000K / 4000K / 6500K
CRI	>80
Luminous flux	410 Lm
Dimmable	No

* Included LED module can be replaced with any GX53 type.

Bespoke options

¹ Specified costs are based on the following RAL colours in fine texture: Graphite Black (RAL 9011), Grey White (RAL 9002), Pine Green (RAL 6028), Olive (RAL 130.70.10), Soft Blue (RAL 240.80.10), Red Brown (RAL 8012).

Additional Information

Mute Panels Fire Treatment

Mute Panels Fire Treatment	Qty	Price
We offer the possibility to treat the Mute panels with a fire retardant product. See the applicable surcharges.	0 - 25	Upon request
	25 - 49	€ 48,00
The treated panels were tested according to EN_13501-1:2018. Contact De Vorm if you would like to receive the corresponding reports.	50 - 99	€ 40,00
	100 - 249	€ 36,00
Note: in the course of the testing, Mute panels were mounted directly on a non-combustible background. If you use any mounting materials during the installation, make sure they also receive a fire-retardant treatment	250 - 499	€ 30,00
	> 500	€ 26,00

Fabrics (Kvadrat and leather)

Fabrics (Kvadrat)

A

Reflect, Remix 3

B

Melange Nap, Hero 2, Re-Wool 2

C

Steelcut Trio 3, Tonica 2, Patio

D

Fiord 2, Revive 1

E

Divina MD, Divina Melange 3, Hallingdal 65, Jaali

F

Coda 2, Razzle Dazzle, Mosaic 2

Leathers (Ohmann)

G

1012

H

Misto

Additional Information

- All upholstery fabrics and leather may develop folds after some time.
- The amount of folds usually depends on the stretch abilities of the fabric.
- Your dealer may give you advice in the field.
- Minor differences in colour and structure in comparison with samples and showroom models may occur.

Ton-sur-ton colour combinations

Ton-sur-ton colour combinations	RAL colour	PET Felt colour
Here you will find the recommended RAL colours to match our PET Felt blends	RAL 1012	Yellow
	RAL 3005	Pink
	RAL 5008	Marine
	RAL 5020	Turquoise
	RAL 6007	Dark Green
	RAL 6020	Green
	RAL 7015	Dark Grey
	RAL 7033	Olive
	RAL 7044	Beige
	RAL 7045	Light Grey
	RAL 8014	Brown

Additional Information

- All upholstery fabrics and leather may develop folds after some time.
- The amount of folds usually depends on the stretch abilities of the fabric.
- Your dealer may give you advice in the field.
- Minor differences in colour and structure in comparison with samples and showroom models may occur.

General Terms & Conditions

Terms & Conditions

Terms

Contractual language

The contractual language is Dutch. The English version of these General Terms and Conditions only serves the convenience of the partner. In the case of conflict between the Dutch and the English version of these terms and conditions, the Dutch version will prevail.

1 Applicability of the General Terms and Conditions

1.1 These General Terms and Conditions are applicable to all offers, agreements and deliveries concerning De Vorm B.V. trading as De Vorm and hereafter named "De Vorm", and all associated products. In these General Terms and Conditions, the opposite party to De Vorm shall further be referred to as "the Client".

1.2 Any purchase conditions of the Client shall not seclude or restrict these General Terms and Conditions.

2 Offers and agreements

2.1 All offers and quotations by De Vorm are without commitment.

2.2 Agreements between De Vorm and the Client are only achieved, when they have been confirmed explicitly in writing by De Vorm. Orders may only be cancelled upon approval by De Vorm.

3 Delivery times

Delivery times as stated by De Vorm are solely an indication of a tendency and may not be seen as definite date, if it hasn't been agreed on otherwise in an explicitly written form.

4 Force majeure and changes of circumstances

4.1 If, after the achievement of an agreement, the prices for primary products, wages, import procedures, taxes or other external costs (if not an effect of currency changes) rise, then De Vorm is entitled to adjust their retail prices accordingly. In such circumstances, De Vorm will inform the Client as soon as possible, which entitles the Client to terminate the agreement within 8 days.

4.2 If De Vorm is unable to execute an agreement as a result of force majeure, De Vorm is entitled to dissolve the agreement either in its entirety or in part or to halt its obligations until the state of force majeure has passed. The Client is then obligated to pay for the already delivered goods.

5 Variations

All data, models and images concerning colours, materials, measures and processing are sole indications. Occurring variations may not form a ground for complaints, compensations, termination of an agreement or price deductions, if these variations are considered to be of minor importance.

6 Deliveries

Orders are only delivered postage free, if it has been explicitly agreed on. If goods are not delivered postage free, De Vorm is entitled to charge shipping costs.

7 Risk

The risk for all products to be delivered, devolves from De Vorm upon the Client once they have left De Vorm's places of transshipment, whereby it is of no concern, what has been agreed on beforehand between De Vorm and the Client regarding transport and insurance.

8 Refusal of delivery by the Client

If the Client refuses a delivery, De Vorm is entitled to charge him with all resulting costs. Furthermore, De Vorm may, in this case, terminate the agreement, reserving the right to demand total compensation.

9 Payment

9.1 De Vorm is entitled to demand (partial) advance payment or pay on delivery at all times.

9.2 If goods are delivered on account, the payment must be made within 14 days, whereby the Client is not entitled to any price deductions or offsetting.

9.3 If a due date for payment is exceeded and no (partly) payment has been received, the Client will be legally in default and charged to pay daily interest corresponding to the state interest rate. The Client will be charged with all costs such as legal costs and extrajudicial and judicial costs, including costs for legal aid, bailiffs and debt collecting agencies, that accrued for De Vorm due to late payments. Extrajudicial costs are set for this purpose at no less than 15% of the sum due, with a minimum of € 150,- excl. VAT.

10 Grant of a delay

If the Client is in default or if De Vorm has good reason to presume that the Client does not or cannot adequately comply with his obligations and/or on time towards De Vorm, then De Vorm will be entitled to (partly) suspend the execution of all agreements or to dissolve them completely or in part without giving notice of default or judicial intervention being required and without being obliged itself to pay any compensation, whereby any obligations of the Client may be made enforceable immediately.

11 Reservation of ownership

11.1 All delivered products remain the property of De Vorm until the Client has adequately complied with all his obligations towards De Vorm according to the terms and conditions of the agreement.

11.2 The Client is only allowed to sell the products, that have remained the property of De Vorm in regards to this condition, within the scope of his company's normal exercises.

11.3 If the Client is in default or if De Vorm has good reason to presume that the Client does not or cannot adequately comply with his obligations towards De Vorm, then De Vorm will be entitled to reclaim delivered products from the Client or from third parties, who are engaged in business with the Client. The Client has to grant full cooperation in this case.

12 Claims

12.1 Within 10 days after receipt of the products - and immediately in case of external damages - the Client has to file and send a detailed and precise claim in writing to De Vorm, in which he presents his complaint.

12.2 Without prejudice to the generality of the foregoing, the Client is obliged to examine the delivered products before they are taken in use, adjusted or sold.

13 Returns

Returns of delivered products may only take place after confirmed in writing by De Vorm, whereby De Vorm is entitled to issue instructions regarding the manner of shipping.

14 Intellectual property rights

De Vorm has and keeps all intellectual property rights based and founded on the design.

15 Liability for damage

15.1 De Vorm is not liable for damage as a result of inappropriate or misapplied utilisation and much else, as long as the damage was not caused directly and solely due to wanton negligence or intent by De Vorm.

15.2 A damage is only qualified for compensation, if the Client has incontrovertibly stated, that the damage occurred due to a circumstance or incident for which De Vorm can be held legally liable.

15.3 Damage due to diminished win or lost profits is not qualified for compensation in any case.

15.4 Damage in association with damage or loss of a business or injury of a person is qualified for compensation up until an amount of the maximum order value that applies to the (part) delivery, with an understanding that the amount may not be higher than € 45.000,- and in any case at all times limited to a maximum of the amount that the insurance of De Vorm covers.

15.5 The Client prevents De Vorm from liability and compensation for damage caused by third parties, that were involved in the execution of the agreement on request by and with confirmation of the Client. The same applies to damage caused by materials, that were delivered by third parties on request by and with confirmation of the Client.

15.6 De Vorm is not liable for damage caused by inappropriate or misapplied utilisation of the delivered goods.

16 Dutch law

The Dutch law applies to this agreement. In case of dispute, the judge of the city, in which De Vorm is located, will be authorised, unless the dispute exceeds the relative competence of the circuit judge.

Terms & Conditions

Conditions

Lead time production

The lead time of production accounts for 6 - 8 weeks following the order receipt or when payment in advance is demanded, following receipt of payment. For furniture orders in non-standard sizes or non-standard finish, the production time can be longer than specified above. You are welcome to contact De Vorm for more information about lead times.

Payment NL

Payment must be made within 14 days following the invoice date. The invoice will be received at the moment of delivery.

Exceptions:

First orders demand a complete advance payment.
 Follow-up orders with an order amount above € 5.000,00 ex. VAT and Follow-up orders that include tailor-made products regardless of the amount demand a prepayment of 30% when order is placed, 60 % before delivery and 10 % within 14 days after delivery. The delivery time will commence from the moment of receipt of prepayment.

Payment foreign countries

Payment must be made within 14 days following the invoice date. The invoice will be received at the moment of delivery.

Exceptions:

First orders demand a complete advance payment.
 Follow-up orders with an order amount above € 1.000,00 excl. VAT and that include tailor-made products regardless of the amount demand a prepayment of 50% when order is placed and 50% before delivery. The delivery time will commence from the moment of receipt of payment.

Transport

All prices of De Vorm are ex works. De Vorm will give a quotation for shipping. Quoted shipping costs are based on delivery in a certain week on the ground floor behind the first door.

Warranty & Maintenance

For more information about our warranty conditions, consult the terms of warranty of De Vorm on For more information about maintenance, consult our maintenance instructions

Colours & deviation

Minor differences in colour and structure in comparison with the samples and showroom models as well as minor deviations in dimensions may occur.

DeVorm



meinema
interieur | ontwerp | uitvoering

Info@meinema.nl

0031 - 20 311
8396